

CITY OF DAYTON, OREGON

HWY 221 SEWER SYSTEM IMPROVEMENT

APRIL 2024

SECTION 13420

INSTRUMENTS

TABLE OF CONTENTS

REFERENCE DOCUMENTS

SECTION 13420 – INSTRUMENTS

DRAWINGS

BILL OF MATERIALS

CUT SHEETS

MAGNETIC FLOW METER AND TRANSMITTER



OPTIMAL CONTROL SYSTEMS, INC.

2324 Three Lakes Road SE

Albany, OR 97322

Phone: (541) 967-9323

Fax: (541) 967-9485

Project No. 0324-19SSE

THIS PAGE LEFT BLANK

SECTION 13420

INSTRUMENTS

PART 1 GENERAL

1.1 SUMMARY

A. Section Includes

1. This section includes the requirements pertaining to the measurement and control instruments.

1.2 REFERENCES

A. American National Standards Institute (ANSI).

1. 51.1-1979 - (R1993) - Process Instrumentation Terminology.
2. 5.1-1984 - (R1992) - Instrumentation Symbols and Identification.

B. Instrumentation, Systems, and Automation Society (ISA).

1. 5.3-1983 - Graphic Symbols for Distributed Control/Shared Display Instrumentation, Logic, and Computer Systems.

C. National Fire Protection Association (NFPA) 70 - National Electrical Code.

D. National Electrical Manufacturer's Association (NEMA).

1. 1-2000 - Industrial Control and Systems General Requirements.

E. Underwriters Laboratory (UL).

1. 508 - Industrial Control Equipment.
2. 3121-1 - Standard for Safety for Process Control Equipment.

1.3 DEFINITIONS

- ###### A. Manufacturer's Representative - manufacturer's authorized employee of the service division.

1.4 SUBMITTALS

- ###### A. Contractor shall submit all the product data in Division 16 at the same time. Piecemeal submittals will be rejected as incomplete.
1. The product data shall be bound in a three ring binder with tabs for each Section. The tabs shall be numbered to match the specification Section numbers. Submittals not bound and labeled as specified will be rejected as incomplete.
 2. A submittal is required for each product specified. Each individual product submittal shall have the corresponding Reference Keynote Number (example - 13420.F21) typewritten in the upper right hand corner of the submittal. The submittals within each Section tab shall be in the same sequential order as they are listed in the specification Section. Submittals not containing the Reference Keynote Number will be rejected as incomplete.

3. No typical submittals will be accepted. Each submittal shall be project specific and clearly identify specifically which components or parts are being submitted for approval. Any product submittals, such as a catalog sheet, which do not clearly identify which components or parts are being submitted for approval, will be rejected as incomplete.

B. Product Data

1. Pursuant to Section 01300 – Contractor Construction Submittals.
2. Manufacturer's data including materials of construction, equipment weight and related information for each item specified in PART 2 PRODUCTS

C. Quality Assurance/Control Submittals

1. Manufacturers' instructions for each item specified in PART 2 PRODUCTS.
 - a. Complete user manual including installation, wiring schematic, programming, calibration, communication, diagnostics, troubleshooting, recommended spare parts, and maintenance recommendations or requirements.

1.5 SEQUENCING

- A. CONTRACTOR shall not energize instrumentation until the completion of the continuity test certification and certification of installation by manufacturer's representative.

1.6 SYSTEM START UP, COMMISSIONING, AND OWNER'S TRAINING

- A. Pursuant to Section 13490 Measurement and Control Commissioning.

PART 2 PRODUCTS

2.1 EQUIPMENT

A. Magnetic Flow Meter and Transmitter (13420.F20).

1. Magnetic flow meter shall be provided as shown on the Drawings with a remote transmitter.
2. Provide a pair of ground rings for each meter installation. The ground rings shall be bonded to ground per the meter manufacturer's instructions.
3. Magnetic flow meters shall be FM approved non-incendive Class I, Division 2.
4. The meter body shall be 6" diameter flanged style with Class 150, A105, carbon steel flanges in accordance with ANSI B16.5.
5. The meter shall be equipped with a remote transmitter rated NEMA 4X and 120 volt AC input power. The transmitter shall display instantaneous flow rate and totalized flow. The meter shall be configured to permit the transmission of instantaneous flow rate over a 4-20mA DC output, provide a pulsed output for totalizing flow, all transmitted to the graphic data manager as shown on the drawings.
6. Magnetic flow meters shall indicate, totalize, and transmit flow information.

7. Magnetic flow meters shall use pulsed AC measurement technology. Pulsed DC measurement technology is not acceptable.
8. Magnetic flow meters shall include an auto-zero feature.
9. Magnetic flow meters shall compensate for eddy currents.
10. Magnetic flow meters shall be designed for bi-directional measurement of flow in a full pipe with fluid conductivity as low as 5 $\mu\text{S}/\text{cm}$, without preamplifiers.
11. The electromagnetic induction flow meter shall generate a voltage linearly proportional to flow for full-scale velocity settings from one to 33 feet per second. Standard accuracy of the pulse output shall be $\pm 0.5\%$ of rate $\pm 0.05\%$ of full scale (33 ft/s) for all meters.
12. The flow meter shall be equipped with "heartbeat technology" which allows the end user the ability to verify calibration with the equipment left in place with their staff.
13. All components of the flow meter, including meter tube, sensors and recorder/totalizer shall be products of a single manufacturer.
14. Magnetic flow meter flow tubes shall be factory assembled units comprised of a carbon steel spool piece and sensors.
 - a. Flow tube flanges shall be carbon steel, conforming to AWWA C110, and shall match the flange style of the piping to which they are connected.
 - b. Flow tubes shall be provided with stainless steel retention bolts.
 - c. Flow liner shall be polyurethane.
15. Magnetic flow meter sensors shall be solid state design, each with a pair of sensing electrodes, exciter coil, sensor reference coils, and internal grounding electrode.
 - a. Magnetic flow meters shall be provided with a minimum of two opposed sensors to distribute the magnetic field over the entire cross-sectional area of the flow tube, and to allow continued operation and flow sensing, with reduced accuracy, in the event of a single sensor failure.
 - b. Sensor grounding and sensing electrodes shall be stainless steel.
 - c. Sensors shall automatically compensate for media noise including: electrochemical effects; entrained magnetic particles; particulate impact on electrodes; frictional effects against electrodes; variable conductivity; and coated electrodes.
 - d. Sensor accuracy shall be unaffected by electrode coatings.
 - e. The meter shall incorporate a high impedance amplifier of 1012 ohms or greater, eliminating the effect of buildup on the electrodes. The meter shall utilize bipolar pulsed DC coil excitation with automatic coil-current fine tuning by the microcontroller to adjust the sensor current within a tolerance of $\pm 100\text{mA}$. The amplifier shall incorporate 3-stage signal processing to maintain system accuracy by the use of a 26 bit analog/digital converter. The first stage will adjust the common-mode rejection ratio to filter out noise. The second stage will incorporate an INTEGRATED AUTOZERO function, which compensates for any external interference signals and eliminates zero drift. Manual zero adjustments shall not be required even at start-up. In stage three, the measuring signal will be amplified by an AUTOGAIN function,

depending on the actual amplitude of the flow signal, to automatically increase the measurement resolution at various flow rates, providing a turndown of at least 1000:1. To further ensure the specified accuracy, the electronics shall automatically perform internal temperature drift compensation. Power consumption shall be no more than 15 VA, independent of meter size. Upon any power failure, the unit will retain all setup parameters and accumulated measurements internally in non-volatile memory. All units will be protected against voltage spikes from the power source by utilizing internal transient protection.

16. The magnetic flow meter transmitter shall be microprocessor based with integral electronics. The flow meter shall have a 2-line push-button display used for programming as well as for simultaneous display of flow rate and total flow in user-selectable engineering units, and readout of diagnostic error messages, selectable from 12 standard languages. The microprocessor shall safeguard against entering of invalid data for the particular meter size, and all programming parameters shall be access-code protected. The electronics shall include infinitely adjustable low flow cutoff.
 - a. Transmitter power supply shall be 120VAC, or 24VDC as shown on the Drawings.
 - b. Transmitters shall be shielded or filtered from common RF noise effects including: radio transmissions; variable frequency drives; etc.
 - c. Transmitters shall be housed in a corrosion-resistant epoxy painted, cast aluminum, NEMA 4X (IP67) enclosure, suitable for conduit connections, and shall include a clear polycarbonate window to allow viewing of the display without opening the enclosure.
 - d. Transmitter operation, configuration, and calibration shall be via the keypad with visual prompts and built-in help at the LCD display.
 - e. The flow meter shall have the capability of being programmed remotely using HART/analog protocol.
 - f. Transmitter display shall indicate flow rate and/or total flow in user-selectable units of measure.
 - g. Transmitters shall include:
 - 1) Isolated, independently configurable 4-20 mA analog output. Response time shall be adjustable between 0.05 and 100 seconds.
 - 2) Configurable pulse output for volume units per pulse, or frequency proportional to flow rate. Frequency shall be adjustable up to 10kHz and pulse width shall be adjustable between 0.05 and 2 seconds.
 - 3) Totalizers for forward, reverse, net, and gross total flow, with user-specified volume units.
 - 4) Independently configurable contact inputs, programmable for measured value suppression, totalizer reset, or error-message reset.
17. The meter shall be provided with a minimum of 0.5% calibration.
18. The tests and the associated documentation will be able to be retained in an electronic format and convertible into a hard copy document compatible for customer review or printing. The technology is commonly referred to by the

manufacturer as "Heartbeat Technology". The data format will define all meter settings, ranges, fail-safes, and configuration detail to conform to these requirements. Sensor model, serial number, and test result will be identified for each verification in a date recorded format.

19. The magnetic flow meter shall be an Endress+Hauser Proline Promag W 400 Series model number, Promag 5W4C1F-C6-I-L-H-N-XX-D-U-A1K-G-A+AA-EB, or approved equal.
 - a. 5W4C1F Size = 6" Diameter Pipe.
 - b. C6 Approval = CSA C/US NI Cl.1 Div.2 gr. U
 - c. I Design = Fixed Flange, 0 x DN Inlet/Outlet Runs
 - d. L Power Supply = 100-240VAC / 24 VAC/DC.
 - e. H Output; Input = 4-20mA HART, Pulse/freq. output switch output.
 - f. N Housing = Remote Polycarbonate.
 - g. XX Cable, Remote Version = CONTRACTOR to verify lengths.
 - h. D Electrical Connection = Thread NPT ½ inch.
 - i. U Liner = Polyurethane.
 - j. A1K Process Conn. = 150, carbon steel, flange joint, ASME B16.5
 - k. G Electrodes = 1.4435/316L Bullet Nose.
 - l. A Calibration = 0.5%
 - m. AA Operation Language Display = English
 - n. EB Application Package = Heartbeat Verification + Monitoring

~~B. Submerged Hydrostatic Level Transducer (13420.L20).~~

- ~~1. Submerged hydrostatic level element shall be provided as shown on the Drawings.~~
- ~~2. Submerged hydrostatic level element shall be 24 VDC, loop powered.~~
- ~~3. CONTRACTOR shall determine correct sensor cable length based on installation requirements.~~
- ~~4. Submerged hydrostatic level element shall consist of variable capacitance, gauge pressure sensing assembly enclosed in submersible type 316 stainless steel housing with aluminum oxide ceramic sensor.~~
- ~~5. CONTRACTOR shall determine correct sensor range based on installation requirements.~~
- ~~6. Submerged hydrostatic level element seals shall be EPDM.~~
- ~~7. Submerged hydrostatic level element cables shall be mounted with cable-mounting screw.~~
- ~~8. Submerged hydrostatic level element signal output shall be analog with flexible sealing of 4-20 mA HART in proportion to level.~~
- ~~9. The accuracy shall be ± 0.2% of the set span including hysteresis and non-repeatability; Long term stability: ±0.1% of Upper Range Limit (URL) per year and must be capable of platinum accuracy of ± 0.1% of the set span.~~
- ~~10. Provide intrinsically safe barrier / relay as required.~~
- ~~11. Provide Endress & Hauser Waterpilot FMX21 transmitter model FMX21-CD-2-1-1K-G-E-25-A-PO-PS-PU, or approved equal.~~
 - ~~a. CD Approval = CSA Class I, Div. 1, Grade A-D~~

- b. 2 ~~Output; Input = 4-20mA HART~~
- e. 1 ~~Probe Tube = 316L, d=0.87in~~
- d. 1K ~~Sensor Range = CONTRACTOR shall determine correct sensor range based on installation requirements.~~
- e. G ~~Reference Accuracy = Platinum.~~
- f. E ~~Calibration = inH2O/ftH2O~~
- g. 25 ~~Probe Connection = Shortable, PE cable. CONTRACTOR to determine lengths.~~
- h. A ~~Seal = FKM Viton~~
- i. PO ~~Accessory Enclosed = Suspension Clamp~~
- j. PS ~~Accessory Enclosed = Terminal Box, IP66/67~~
- k. PU ~~Accessory Enclosed = Additional Weight, 316L~~

PART 3 EXECUTION

3.1 INSTALLATION

A. General

1. All identification labeling shall be in compliance with Section 16075 Electrical and Control Identification.
2. Field wiring shall be installed according to the Drawings and manufacturer's instructions.
3. Wire and cable shall be connected from terminal to terminal without splices.
4. Wire and cable shall be arranged in a neat manner and securely supported in cable groups.
5. Wiring shall be protected from sharp edges and corners.
6. Float switches shall be installed using a stainless steel type CGB cord grip to seal the end of the conduit.
7. All equipment to be located as shown, and rigidly attached to walls or floor as shown or directed by Owner's Representative. Install all equipment in strict accordance with manufacturer's recommendations and in compliance with all rules and regulations of jurisdictions having authority. All work to be set plumb or level, as applicable, to be rigid and neat in appearance. Provide shop drawing of equipment and accessory layout and manufacturer's recommendations for installation and accessories before installing.
8. All piping shall be installed as shown on the plans or as directed by Owner's Representative.
9. All piping shall be supported as required to eliminate stresses on equipment including, but not limited to, the feed pump and chlorine tablet feeder.

3.2 ADJUSTING

- A. The overall accuracy of each instrumentation system or loop shall be as indicated in the specification for that system or loop. Each individual instrument shall have a minimum

accuracy of ± 0.2 percent of full scale and a minimum repeatability of ± 0.25 percent of full scale unless otherwise indicated.

- B. The Contractor shall furnish a factory representative to perform inspection, startup and training services. The factory representative shall be experienced in the operation and maintenance of the equipment.
- C. The factory representative shall check the installation and supervise initial startup of the equipment. He shall certify that the installation is correct and that the equipment has operated satisfactorily.

END OF SECTION

THIS PAGE LEFT BLANK

GENERAL DESIGN CRITERIA (Dayton Main PS)
**Elevations listed below are based on NAVD 1988 vertical datum.

1. PS Site Location & Info:

- Coordinates: 45°13.111'N 123° 4.269'W
- 100 Yr Flood Elev: 106 ft (NAVD 1988), 102.65 (NGVD 1929)
- Basin area: ~48 acres sewered, ~13 acres unsewered

2. Design Flows (2042):

- Dry Weather Flow Assumptions: (maximum 143 EDUs) x (2.5 people/EDU) * (120 gpcd)
- Average Dry Weather Flow (ADWF): 0.042 MGD (30 gpm)
- Average Wet Weather Flow (AWWF): 0.1287 MGD (90 gpm) ADWF * 3.0 PF
- Peak Day Flow (PDF): 0.2397 MGD (167 gpm) AWWF + 1500 gpad I/I allowance

3. Pump Station Wetwell:

- Type: Duplex Submersible Non-clog (see data below)
- Wet Well Type: Precast Concrete w/Flygt TOPS hopper bottom
- Wet Well Diameter: 6 feet (211.5 gal/ft)
- Rim elevation: 121.85 ft (NGVD 1929) = 125.2 ft (NAVD 1988)
- Sump bottom elevation: 104.73 ft = 108.08 ft (NAVD 1988)
- Inlet pipe diameter: 10-inch
- Influent Invert Elev: ±109.73 ft (NGVD 1929) = 113.08 ft (NAVD 1988)
- Reference only, existing wetwell influent invert = ±112.5, NGVD 1929 datum, or 115.85 ft, NAVD 1988
- Add. Pipe Stubs: None

- Wet Well Depth (sump to hatch): 17.12 ft (sump bottom elevation 104.73 ft, or 5' below influent invert)
- Wet Well Depth (sump to overflow): 13.42 ft
- Pump Off Level (Low Water): ±105.9 ft (±14" above wetwell bottom)
- Pump On (Max Operating Level): ±109.48 ft (3" below influent inv, ±3.58' above low water shutoff)
- Operational Storage: ±600 gallons (assumes 20% of volume from pump-off to pump-on is occupied by insert, fillets, etc.)
- Pump Cycle time, worst case: ±4.5 starts/hour (2.25 starts/hour/pump @ 180 gpm inflow)
- Minimum Cycle time rating for each pump: 30 starts/hour

- Overflow:
 - ◆ Overflow Pipe Inv: ±118.15 ft
 - ◆ Location: from Manhole adjacent to wetwell

- Overflow Storage Provided: ±4,710 gallons (pump-on level to overflow), including only new MHs new 10" pipe
 - ◆ Wetwell overflow storage: ±1,880 gal (±8.9' storage to overflow invert, 211.5 gal/ft)
 - ◆ New gravity sewer manhole storage: ±2,070 gal (±22' cumulative storage, 94 gal/ft)
 - ◆ New 10" gravity sewer pipes: ±760 gal (±185' cumulative storage, 4.1 gal/ft)

- Time to Overflow: ~157 min. @ 30 gpm (ie. base design sewage flow)
~28 min. @ 167 gpm (ie. peak day design flow)

4. Sewage Pumps:

- Type: Submersible sewage pumps
 - ◆ Model: Flygt NP-3127HT (488)
 - ◆ Number: 2 equal size
 - ◆ Pump Weight: 325 lbs
 - ◆ Size: 10 hp, 480 V, 3 phase
 - ◆ Discharge Size: 4-inch
 - ◆ Max Speed: 1750 rpm
 - ◆ Speed Control: Variable Frequency Drive (VFD)
 - ◆ Pump Shutoff Head: 80 ft
 - ◆ Mix-Flush Valves: none

- Pump Removal: Service Boom Truck adjacent to wetwell.

- Design Pump Discharge Rates (assumes old FM with C=120)
 - ◆ ±432 gpm @ 60 Hz w/TDH = 50.5'
 - ◆ ±232 gpm @ 45 Hz w/TDH = 32.5'
 - ◆ ±166 gpm @ 41 Hz w/TDH = 29'
 - ◆ ±40 gpm @ 35 Hz w/TDH = 25.4'

- Pump Discharge Piping (wetwell, vaults & force main)
 - ◆ 4" riser pipes in wetwell & thru valve vault (6.4 fps @ 250 gpm, 8.3 fps @ 325 gpm)
 - ◆ 6" pipes between vaults (3.7 fps @ 325 gpm)
 - ◆ 6" force main (3.7 fps @ 325 gpm)

5. Pump Control/Liquid Level Sensing:

- Primary Pump Control:
 - ◆ Primary level sensor: Flygt submersible pressure transducer
 - ◆ Primary High Level Alarm based on signal from pressure transducer

- Backup Level Control:
 - ◆ 10 sensor probe (6" spacing), with different sensors connected to lead/lag pump start & pump stop relays.
 - ◆ Backup High Level Alarm; bottom sensor of 10 sensor probe
- Overflow Alarm, single sensor probe
- VFD motor controllers/motor starters, one per pump
- Phase rotation/phase imbalance protection

6. Valves, Pressure Monitoring:

- Check Valves: Rubber flapper swing check, one per pump, backflow device to drain force main
- Pump Isolation Valves: Resilient wedge gate valve w2-inch square operating nut
- Pressure Gauges: Ashcroft Mini-Diaphragm Seal configured for 3½" pressure gauge (one for each pump, between check valve & isolation valve)

7. Flow Metering: Effluent Flow Meter

- Mag Flow Meter in Valve Vault (6" diameter)
- Local Readout in control building, 4-20 mA signal to SCADA
- Provide replacement spool for insertion during meter servicing

8. Bypass Pumping Provisions:

- Valved emergency bypass pump port
- Bypass pump connection: Male 6" Camlock coupling, Camlock cap w/1/8" hole drilled in cap.

9. Pump Discharge Piping/Force Main and Head Conditions:

- Force Main Pipe Discharge Location
 - ◆ Discharge Location: MH 76, north of bridge, south of Mill Street
 - ◆ FM Discharge inv: ±131.25 ft @ MH (NAVD 1929) (±134.6 ft NGVD 1988)

• Pump Discharge Piping & Force Main Size & Length

- ◆ 4-inch Riser Pipe (±10.25 ft)
- ◆ 6-inch Horiz. through vault (±18 ft)
- ◆ 6-inch DI & PVC, vault to discharge (±730 ft)

• Force Main Volume & Turnover

- ◆ 6-inch FM vol/ft = ±1.47 gpf * 730 ft = 1,075 gal
- ◆ FM turnover @ ADWF (30 gpm) = 35 min
- ◆ FM turnover @ AWWF (90 gpm) = 12 min

• Pumping Static Head Conditions

- ◆ Maximum Static Head: ±25.4 ft (low water/pump-off elev. to FM discharge inv.)
- ◆ Minimum Static Head: ±22 ft (high water/pump-on elev. to FM discharge inv.)

• Check Valve Static Head Conditions:

- ◆ Check valve elev: 116.5 ft
- ◆ Static Head at Discharge Check Valve: ±14.75 ft (ie. check valve inv to FM discharge inv.)

• ARV Valve Static Head Conditions:

- ◆ ARV valve elev: ±120.5 ft
- ◆ Static Head at Discharge Check Valve: ±10.75 ft (ie. ARV to FM discharge inv.), ±4.65 psi

10. Hydrogen sulfide Control System:

- None

11. Standby Power System:

- Type: Permanent diesel Powered Generator (Cummins 30 KW C30 D6)
- Location: Outside with manufacturer's weather & Level II sound enclosure
- Mounting: On reinforced concrete slab
- Rating: 30 kw, 480V, 3 phase
- Transfer Switch: Automatic Transfer Switch (ATS)
- Silencer: Critical grade silencer
- Minimum Equipment to Operate: 2 sewage pumps started sequentially, site lighting, telemetry
- Exerciser: Automatic weekly
- Subbase Fuel Tank: Sub-base tank, 74 gallon capacity
- Generator Run times: ±45.5 hrs @ 50% load (1.62 gph), ±26 hrs @ 100% load (2.81 gph)

12. Control Shelter & Site:

- Prefabricated Control Shelter
 - ◆ Flygt 8'x 12' (fiberglass)
- Exterior lights:
 - ◆ Wall pack light on building above door
 - ◆ Photocell operated site light adjacent to wet well
- Fence: Vinyl Coated chain link fabric and posts along retaining wall

13. Telemetry:

- Cellular modem, connected to existing City SCADA system

13. Air Release Valves:

- Adjacent to PS Site: 3" Vent-O-Mat RGXII

GENERAL SEQUENCE OF OPERATIONS (Schedule A - Hwy 221 Pump Station)

1. The following sequence of operations does not include all steps and is intended only to outline a general framework of construction that summarizes the project sequencing requirements and maintains utility service during the course of the work. In addition to the issues outlined herein, the Contractor shall conform to all City, County, and State conditions and directives concerning the work wherein each has jurisdiction. Construction sequencing shall remain the Contractor's responsibility, and the Contractor may propose alternate construction sequencing, but such alternate sequencing must address the issues noted herein.

- The work shall be performed in a manner designed to maintain operation of the existing sewer system. Contractor shall notify the City and all affected residents and businesses a minimum of 48 hours prior to any interruption of service.
- No trenches (in public roads or in driveways accessing public roads) shall be left in an open condition overnight. All such trenches shall be closed before the end of each work day and normal traffic flow restored.
- Contractor to coordinate with and obtain ODOT approval for all required traffic control plans (TCP) & temporary pedestrian access route (TPAR) plans during all phases of construction with impact vehicular or pedestrian traffic.
- City forces to operate all valves required to isolate existing force mains, waterlines or hydrants.
- Contractor shall coordinate with City during configuration, testing & startup of control panels, telemetry, generator, SCADA, etc.

2. The work will likely be completed in phases. Some of the work under these phases may occur simultaneously. In general, the phases are:
a. Phase I - Coordination, Submittals, Equipment Procurement, Site Preparation
b. Phase II - Wetwell Excavation & Construction, Pump Discharge Valve Vault Construction
c. Phase III - Site Piping & Force Main Piping, Site Improvements, Control Shelter, Electrical, etc.
d. Phase IV - New Pump Station Startup & Performance Testing, 2 Week Test Operations
e. Phase V - Place New Pump Station in Operation, Finalize Connections, Decommission Existing Pump Station, Final Sitework

3. Phase I - Coordination, Submittals, Equipment Procurement, Site Preparation.

- Submit schedule, equipment and material submittals, shop drawings and sequence of operations (if different than contained herein) to Engineer & City for review and approval.
- Coordinate procurement of materials and equipment.
- Notify utilities and coordinate activities as required.
- Obtain any required building & construction permits, ODOT permits, ODOT approval of TCP & TPAR plans, etc.
- Install erosion control measures.
- Pothole existing utilities, etc. Notify Engineer of any conflicts or discrepancies. Coordinate for with franchise utility companies for relocation of franchise utilities as necessary.

4. Phase II - Wetwell Excavation & Construction, Valve Vault & Meter Vault Construction.

- Prepare and excavate for new wetwell.
- Construct/install new wetwell base slab, structure & top slab. Field core drill for piping penetrations as noted & specified.
- Install valve vault, bypass pump connection MH, etc. Field core drill for piping as required.
- Install discharge piping and appurtenances in wetwell, vault piping, valves & appurtenances, etc.

5. Phase III - Site Piping & Force Main Piping, Site Improvements, Control Shelter, Electrical, etc.

- Construct new gravity sewers (make connections to existing system w/provisions to maintain interim flows to existing pump station until new PS is placed in service).
- Construct interim force main connection at bridge (to allow discharge from either existing PS or new MPS).
- Install new force main & appurtenances from discharge valve vault to bridge & connect to interim connection piping at bridge.
- Construct retaining walls, curb, fence & complete general site grading work.
- Install meter vault, ARV manhole, etc. Core drill for piping as required.
- Install water service & utilities for new pump station as shown.
- Install underground electrical/control conduits & appurtenances, including new power service.
- Construct/install control shelter & appurtenances.
- Construct generator pad, install generator & appurtenances.
- Install/connect electrical/control panels & appurtenances.
- Construct new access drive & maintenance access improvement areas between walkway & retaining wall (TrueGrid Paver system). Complete site grading & surface restoration to the extent possible (ie. prior to removal of existing PS).
- Submit draft equipment O&M manuals.

6. Phase IV - New Pump Station Startup & Performance Testing, 2 Week Test Operations.

- Coordinate with City during programing of pump controllers, transfer switches, telemetry & SCADA system, etc.
- Startup up and test new generator, ATS, pump control panels and all pump station components with clean water prior to turning sewage into new pump station. Contractor responsible for all water trucks, hoses from nearest fire hydrant, equipment & labor, etc. as required to provide fresh water for testing (in sufficient volumes and at sufficient flow rates for pump station performance testing).
- Coordinate with City to verify bypass pumping test (ie. from wetwell into bypass pump port manhole) with Contractor supplied trailer mounted pump (6" engine driven pump).
- Submit final O&M manuals. Final O&M manuals must be submitted and approved by the City prior to placing the new pump station in operation.

7. Phase V - Place New Pump Station in Operation, Finalize Connections, Decommission Existing Pump Station, Final Sitework.

- Place new pump station in operation, provide final operator training.
- The new pump station shall be operated for a minimum of 2 weeks prior to decommissioning the existing pump station and taking it permanently out of service. Coordinate with City to raise the operating levels in the existing pump station above the normal operating levels of the new pump station (ie. so that the existing system will take over automatically if the new pump station fails for any reason).
- Upon authorization by City, complete final force main connection work (ie. remove & plug connection from old PS), complete gravity sewer connection work & final manhole channeling, decommission & demolish existing pump station as required.
- Complete remaining site work & surface restoration.
- Clean up and demobilize from the site.

NO.	DATE	DESCRIPTION	BY
1			

VERIFY SCALE
BAR IS ONE INCH ON
DRAWING
IF NOT ONE INCH ON
THIS SHEET, ADJUST
SCALES ACCORDINGLY

DATE: MAR. 2023
REVISIONS



WESTECH ENGINEERING, INC.
CONSULTING ENGINEERS AND PLANNERS

3941 Fairview Industrial Dr. S.E., Suite 100, Salem, OR 97302
Phone: (503) 585-2474 Fax: (503) 585-3986
E-mail: westech@westech-eng.com

CITY OF DAYTON, OH
HWY 221 SEWER SYSTEM IMPROVEMENTS

DESIGN CRITERIA &
SEQUENCE OF OPERATIONS

DRAWING
G0.4
JOB NUMBER
2609.3075.0

GENERAL SHEET NOTES

1. MOUNT ELECTRICAL EQUIPMENT AT 5'-0" AFF TO TOP OF EQUIPMENT, UNLESS OTHERWISE NOTED.
2. REFERENCE CONDUIT SCHEDULE FOR ROUTING OF CONDUIT HOMERUNS. REFERENCE SECTION 16131 FOR CONDUIT INSTALLATION REQUIREMENTS.

REFERENCE KEY NOTES

DIVISION 16 - ELECTRICAL

16511.I01 LUMINAIRE I01
16512.E02 LUMINAIRE E02

SHEET KEY NOTES

1. AUTOMATIC TRANSFER SWITCH, ATS-1.
2. FLOWMETER TRANSMITTER FIT-100.
3. UNIT HEATER. MOUNT 12" AFF CENTERLINE.
4. DISTRIBUTION PANEL DP-1.
5. MAIN SERVICE DISCONNECT.
6. UTILITY METER.
7. TELEMETRY PANEL, TP-1.
8. PUMP CONTROL PANEL (PCP).
9. VFD-1.
10. VFD-2.
11. LIGHTING PANEL, LP-1.
12. EXTERIOR LIGHT WITH INTEGRAL PHOTOCELL. MOUNT AT 8'-0" AFF TO TOP OF FIXTURE.
13. EXHAUST FAN, EF-1.
14. COLING T-STAT TIED TO EXHAUST FAN, EF-1.
15. FIRE EXTINGUISHER.

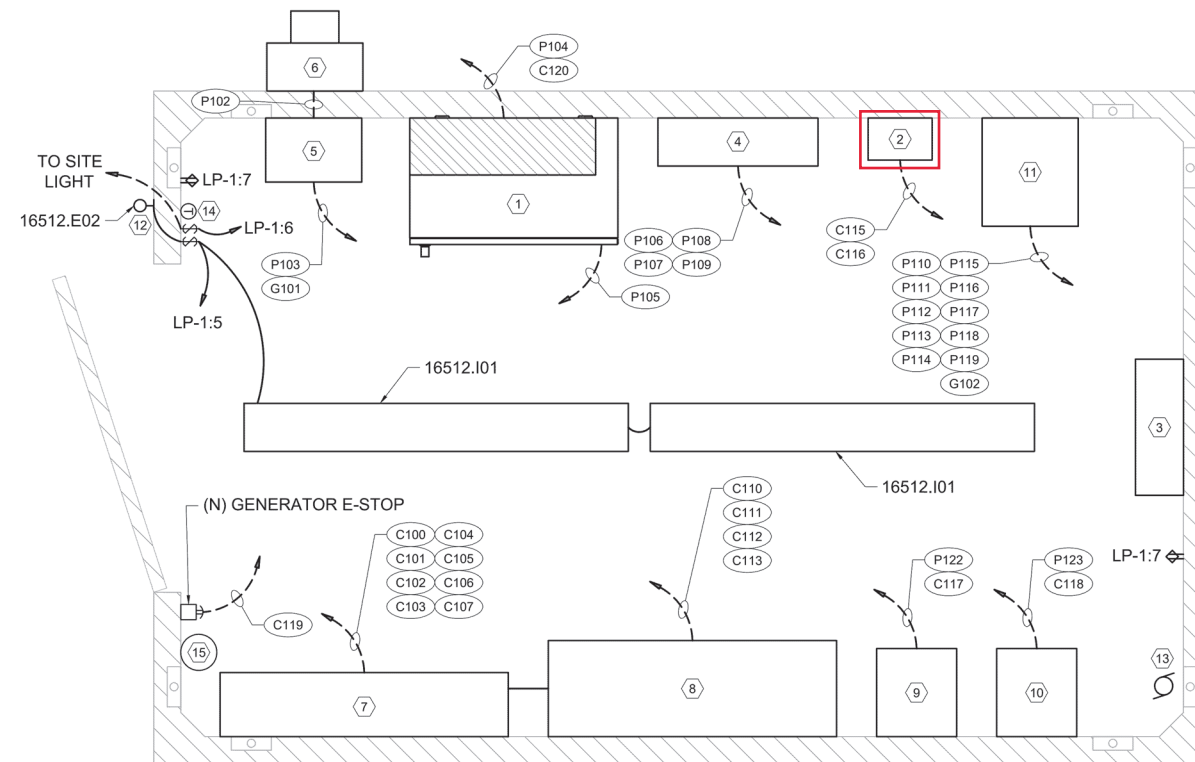

1 CONTROL SHELTER ELECTRICAL PLAN
SCALE: 1" = 1'-0"



NO.	DATE	DESCRIPTION	BY

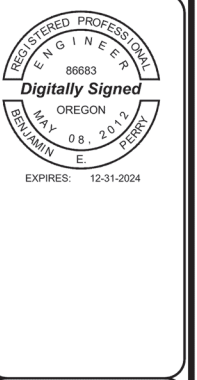

Landis Consulting
ENGINEERING SERVICES
Salem | Lake Oswego
503-584-1576
www.landisconsulting.com

CITY OF DAYTON, OR
HWY 221 SEWER PS IMPROVEMENTS
CONTROL SHELTER ELECTRICAL PLAN

DRAWING
E2.2

JOB NUMBER
2609.3075.0

FIELD

TELEMETRY PANEL TP1

PLC

MAIN FLOW METER

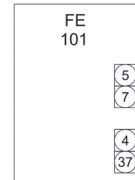

MAIN FLOW REMOTE TRANSMITTER

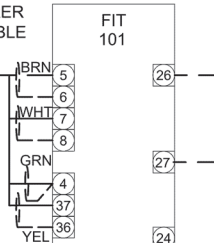

MANUFACTURER SUPPLIED CABLE

MANUFACTURER SUPPLIED CABLE

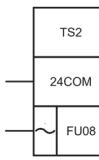
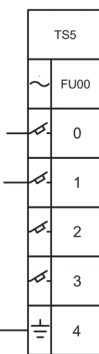
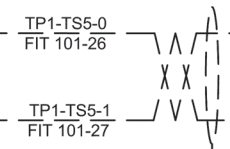

REF SHEET: E7.1
LINE: 18

TP1-TS2-24COM
FIT 101-1

TP1-TS2-FU08
FIT 101-2

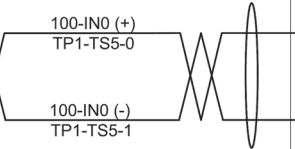
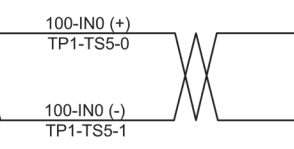

ALLEN-BRADLEY
1762-IF4
RACK 0
SLOT 1

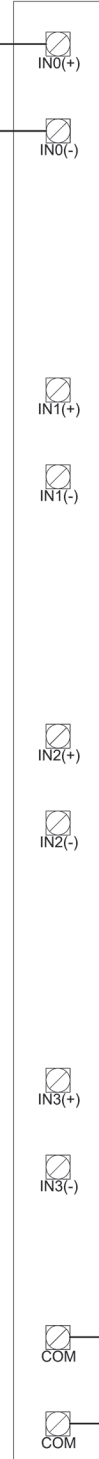

FROM SHEET: E8.2
LINE: 10

24COM

MAIN FLOW TRANSMITTER
FLOW
FIT-101

SPARE

SPARE

SPARE

24COM

24COM

- GENERAL SHEET NOTES**
- CONTRACTOR SHALL INDICATE INSTRUMENT TERMINAL BLOCK NUMBERS ON AS-BUILT DRAWINGS.
- SHEET KEY NOTES**
- MANUFACTURER'S SUPPLIED CABLE - CONTRACTOR SHALL VERIFY INSTALLATION REQUIREMENTS WITH MANUFACTURER'S INSTRUCTIONS PRIOR TO INSTALLATION.

24VDC ANALOG INPUTS
SCHEMATIC SLOT 1
SCALE: NONE

NO.	DATE	DESCRIPTION	BY

VERIFY SCALE
BAR IS ONE INCH ON ORIGINAL DRAWING
IF NOT ONE INCH ON SCALES ACCORDINGLY
DATE: MAY 2023



Landis Consulting
ENGINEERING SERVICES
Salem | Lake Oswego
503-584-1576
www.landisconsulting.com

CITY OF DAYTON, OR
HWY 221 SEWER PS IMPROVEMENTS
24VDC ANALOG INPUTS
SCHEMATIC, SLOT 1

DRAWING
E9.1

JOB NUMBER
2609.3075.0

Bill of Materials



Project: Hwy 221 Sewer System Improvement
Specification Section(s): Section 13420 – Instruments
Date: April 2024

Item No.	Qty.	Tag(s)	Description	Manufacturer	Manufacturer Part Number	Specification Section	Drawing
001	1	FE/FIT-101	Promag W 400, 5W4C1F, DN150 6"	Endress+Hauser	5W4C1F-C6ILHN5DUA1KGA+AAEB	13420.F20	G0.4, M1.1, E2.2, E9.1
002	2	FE/FIT-101	Promag, Grounding Disc/Protection Disc	Endress+Hauser	DK5GD-1FAUL	13420.F20	G0.4, M1.1, E2.2, E9.1
003							
004							
005							
006							
007							
008							
009							
010							
011							
012							
013							
014							
015							
016							
017							
018							
019							
020							
021							
022							
023							
024							
025							
026							
027							
028							
029							
030							
031							
032							
033							
034							
035							
036							
037							
038							
039							
040							

THIS PAGE LEFT BLANK

Configuration summary

Mat. no.	Description Order code	Quantity	Unit
71215560	Promag W 400, 5W4C1F, DN150 6" 5W4C1F-C6ILHN5DUA1KGA+AAEB	1	ST

010	Approval:	C6	CSA C/US NI Cl.I Div.2 Gr. ABCD
011	Design:	I	Fixed flange, 0 x DN inlet/ outlet runs
015	Power Supply:	L	100-240VAC/24VAC/DC
020	Output; Input:	H	4-20mA HART, pulse/freq., switch output
040	Housing:	N	Remote, polycarbonate
045	Cable, Remote Version:	5	125 ft ft coil and signal cable
050	Electrical Connection:	D	Thread NPT1/2
060	Liner:	U	Polyurethane
070	Process Connection:	A1K	Cl.150, carbon steel, flange ASME B16.5
075	Electrodes:	G	1.4435/316L, bullet nose
080	Calibration Flow:	A	0.5%
500	>Operation Language Display:	AA	English
540	>>Application Package:	EB	Heartbeat Verification + Monitoring

THIS PAGE LEFT BLANK

Technical Information

Proline Promag W 400

Electromagnetic flowmeter



Versatile standard flowmeter for the water and wastewater industry

Application

- The bidirectional measuring principle is virtually independent of pressure, density, temperature and viscosity
- Ideal for water measurement, e.g. drinking water, utility water and industrial/municipal wastewater

Device properties

- International drinking water approvals
- Degree of protection IP68 (Type 6P enclosure)
- Approved for custody transfer to MI-001/OIML R49
- Transmitter housing made of durable polycarbonate or aluminum
- WLAN access
- Integrated data logger: measured values monitoring

Your benefits

- Reliable measurement at constant accuracy with 0 x DN run without pressure loss
- Flexible engineering – sensors with fixed flanges or lap joint flanges
- Application suitability – corrosion protection according to EN ISO 12944 for buried or underwater installations
- Improved plant availability – sensor compliant with industry-specific requirements
- Safe operation – no need to open device
- Time-saving local operation without additional software and hardware – integrated web server
- Built-in verification and build-up detection – Heartbeat Technology

Table of contents





About this document	4	Electromagnetic compatibility (EMC)	48
Symbols	4		
Function and system design	5	Process	48
Measuring principle	5	Medium temperature range	48
Measuring system	6	Conductivity	48
Equipment architecture	7	Pressure/temperature ratings	48
Safety	7	Pressure tightness	51
		Flow limit	52
		Pressure loss	52
		System pressure	53
		Vibrations	53
Input	8	Custody transfer mode	54
Measured variable	8		
Measuring range	8	Mechanical construction	54
Operable flow range	12	Dimensions in SI units	54
Input signal	13	Dimensions in US units	74
		Weight	86
		Measuring tube specification	90
		Materials	91
		Fitted electrodes	94
		Process connections	94
		Surface roughness	94
Output	13	Human interface	94
Output signal	13	Operating concept	94
Signal on alarm	15	Languages	94
Low flow cut off	17	Local operation	95
Galvanic isolation	17	Remote operation	95
Protocol-specific data	17	Service interface	97
		Supported operating tools	98
		HistoROM data management	99
Power supply	19	Certificates and approvals	100
Terminal assignment	19	CE mark	101
Pin assignment, device plug	22	UKCA marking	101
Supply voltage	23	RCM mark	101
Power consumption	23	Ex approval	101
Current consumption	23	Drinking water approval	101
Power supply failure	23	HART certification	101
Electrical connection	23	PROFIBUS conformity	101
Potential equalization	27	Modbus RS485 certification	101
Terminals	31	EtherNet/IP certification	101
Cable entries	31	Radio approval	101
Cable specification	31	Measuring instrument approval	101
		Other standards and guidelines	102
Performance characteristics	33	Ordering information	102
Reference operating conditions	33		
Maximum measured error	34	Application packages	102
Repeatability	35	Cleaning	103
Influence of ambient temperature	36	Diagnostics functions	103
		Heartbeat Technology	103
Installation	37	Accessories	103
Mounting location	37	Device-specific accessories	103
Orientation	39		
Inlet and outlet runs	40		
Adapters	42		
Length of connecting cable	43		
Special mounting instructions	43		
Mounting the transmitter housing	45		
Environment	45		
Ambient temperature range	45		
Storage temperature	46		
Atmosphere	46		
Degree of protection	46		
Vibration- and shock-resistance	47		
Mechanical load	48		

Communication-specific accessories	104
Service-specific accessories	105
System components	105
Supplementary documentation	106
Standard documentation	106
Supplementary device-dependent documentation	106
Registered trademarks	107





About this document

Symbols









Electrical symbols

Symbol	Meaning
	Direct current
	Alternating current
	Direct current and alternating current
	Ground connection A grounded terminal which, as far as the operator is concerned, is grounded via a grounding system.
	Protective Earth (PE) A terminal which must be connected to ground prior to establishing any other connections. The ground terminals are situated inside and outside the device: <ul style="list-style-type: none"> ▪ Inner ground terminal: Connects the protective earth to the mains supply. ▪ Outer ground terminal: Connects the device to the plant grounding system.



Communication symbols

Symbol	Meaning
	Wireless Local Area Network (WLAN) Communication via a wireless, local network.
	Bluetooth Wireless data transmission between devices over a short distance.
	LED Light emitting diode is off.
	LED Light emitting diode is on.
	LED Light emitting diode is flashing.

Symbols for certain types of information

Symbol	Meaning
	Permitted Procedures, processes or actions that are permitted.
	Preferred Procedures, processes or actions that are preferred.
	Forbidden Procedures, processes or actions that are forbidden.
	Tip Indicates additional information.
	Reference to documentation
	Reference to page
	Reference to graphic
	Visual inspection

Symbols in graphics

Symbol	Meaning
1, 2, 3, ...	Item numbers
1, 2, 3, ...	Series of steps
A, B, C, ...	Views
A-A, B-B, C-C, ...	Sections
	Hazardous area
	Safe area (non-hazardous area)
	Flow direction

Function and system design

Measuring principle

Following *Faraday's law of magnetic induction*, a voltage is induced in a conductor moving through a magnetic field.

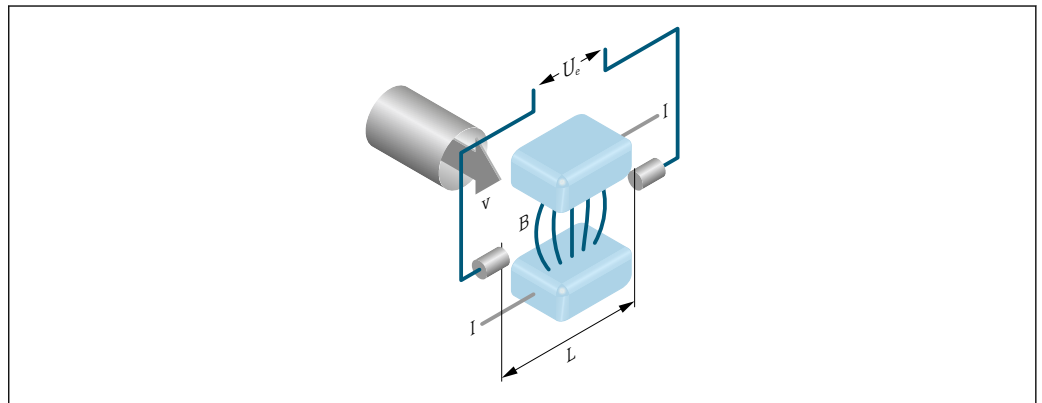

A0028962

- U_e* Induced voltage
- B* Magnetic induction (magnetic field)
- L* Electrode spacing
- I* Current
- v* Flow velocity

In the electromagnetic measuring principle, the flowing medium is the moving conductor. The voltage induced (U_e) is proportional to the flow velocity (v) and is supplied to the amplifier by means of two measuring electrodes. The flow volume (Q) is calculated via the pipe cross-section (A). The DC magnetic field is created through a switched direct current of alternating polarity.

Formulae for calculation

- Induced voltage $U_e = B \cdot L \cdot v$
- Volume flow $Q = A \cdot v$

Measuring system

The device consists of a transmitter and a sensor.

Two device versions are available:

- Compact version - transmitter and sensor form a mechanical unit.
- Remote version - transmitter and sensor are mounted in separate locations.

Transmitter

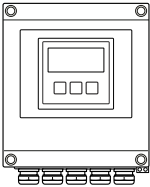
<p>Proline 400</p>  <p style="text-align: right; font-size: small;">A0045222</p>	<p>Device versions and materials:</p> <ul style="list-style-type: none"> ■ Compact version: compact housing <ul style="list-style-type: none"> ■ Polycarbonate plastic ■ Aluminum, AlSi10Mg, coated ■ Remote version: wall-mount housing <ul style="list-style-type: none"> ■ Polycarbonate plastic ■ Aluminum, AlSi10Mg, coated <p>Configuration:</p> <ul style="list-style-type: none"> ■ External operation via four-line, illuminated local display with touch control and guided menus ("Make-it-run" wizards) for applications ■ Via operating tools (e.g. FieldCare) ■ Via Web browser (e.g. Microsoft Internet Explorer) ■ Also for device version with EtherNet/IP output: <ul style="list-style-type: none"> ■ Via Add-on Profile Level 3 for automation system from Rockwell Automation ■ Via Electronic Data Sheet (EDS) ■ Also for device version with PROFIBUS DP output: <ul style="list-style-type: none"> ■ Via PDM driver for Siemens automation system
--------------------------------------------------------------------------------------------------------------------------------------------------------------------------	-----------------------------------------------------------------------------------------------------------------------------------------------------------------------------------------------------------------------------------------------------------------------------------------------------------------------------------------------------------------------------------------------------------------------------------------------------------------------------------------------------------------------------------------------------------------------------------------------------------------------------------------------------------------------------------------------------------------------------------------------------------------------------------------------------------------------------------------------------------------------------------------------------------------------------------------------------------------------------------------------------------------------------------------------------------------------------------------------------------------------------------------------------------------------------------------

Sensor

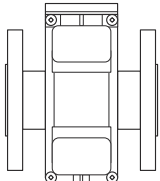
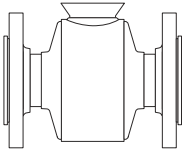
<p>Promag W</p> <p><i>Lap joint flange, lap joint flange, stamped plate or fixed flange with aluminum half-shell housing: DN 25 to 300 mm (1 to 12 in)</i></p>  <p style="text-align: right; font-size: small;">A0017040</p>	<ul style="list-style-type: none"> ■ Nominal diameter range: DN 25 to 3 000 mm (1 to 120 in) ■ Materials → 91
<p><i>Fixed flange with fully welded housing made of carbon steel: DN 25 to 300 mm (1 to 12 in)</i></p>  <p style="text-align: right; font-size: small;">A0022673</p>	

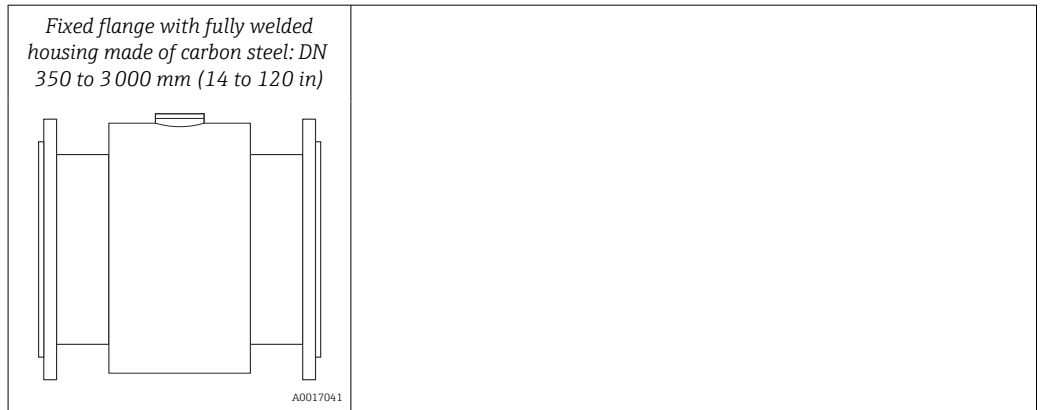

Equipment architecture

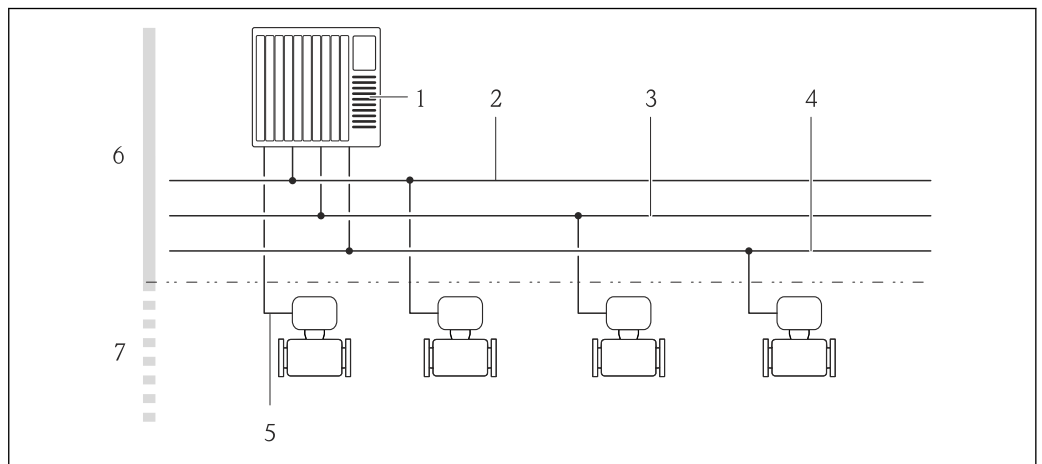

1 Possibilities for integrating measuring devices into a system

- 1 Control system (e.g. PLC)
- 2 EtherNet/IP
- 3 PROFIBUS DP
- 4 Modbus RS485
- 5 4 to 20 mA HART, pulse/frequency/switch output
- 6 Non-hazardous area
- 7 Non-hazardous area and Zone 2/Div. 2

Safety

IT security

Our warranty is valid only if the device is installed and used as described in the Operating Instructions. The device is equipped with security mechanisms to protect it against any inadvertent changes to the settings.

IT security measures, which provide additional protection for the device and associated data transfer, must be implemented by the operators themselves in line with their security standards.

Device-specific IT security

The device offers a range of specific functions to support protective measures on the operator's side. These functions can be configured by the user and guarantee greater in-operation safety if used correctly. An overview of the most important functions is provided in the following section.

Protecting access via a password

Different passwords are available to protect write access to the device parameters or access to the device via the WLAN interface.

- User-specific access code
Protect write access to the device parameters via the local display, Web browser or operating tool (e.g. FieldCare, DeviceCare). Access authorization is clearly regulated through the use of a user-specific access code.
- WLAN passphrase
The network key protects a connection between an operating unit (e.g. notebook or tablet) and the device via the WLAN interface which can be ordered as an option.

User-specific access code

Write access to the device parameters via the local display or operating tool (e.g. FieldCare, DeviceCare) can be protected by the modifiable, user-specific access code.

WLAN passphrase: Operation as WLAN access point

A connection between an operating unit (e.g. notebook or tablet) and the device via the WLAN interface, which can be ordered as an optional extra, is protected by the network key. The WLAN authentication of the network key complies with the IEEE 802.11 standard.

When the device is delivered, the network key is pre-defined depending on the device. It can be changed via the **WLAN settings** submenu in the **WLAN passphrase** parameter.

General notes on the use of passwords

- The access code and network key supplied with the device should be changed during commissioning.
- Follow the general rules for generating a secure password when defining and managing the access code or network key.
- The user is responsible for the management and careful handling of the access code and network key.

Access via Web server

The device can be operated and configured via a Web browser with the integrated Web server. The connection is via the service interface (CDI-RJ45) or the WLAN interface. For device versions with the EtherNet/IP and PROFINET communication protocols, the connection can also be established via the terminal connection for signal transmission with EtherNet/IP or PROFINET (RJ45 plug).

The Web server is enabled when the device is delivered. The Web server can be disabled if necessary (e.g. after commissioning) via the **Web server functionality** parameter.

The device and status information can be hidden on the login page. This prevents unauthorized access to the information.



For detailed information on device parameters, see:
The "Description of Device Parameters" document → 106

Input

Measured variable

Direct measured variables

- Volume flow (proportional to induced voltage)
- Electrical conductivity



In custody transfer: only volume flow

Calculated measured variables

Mass flow

Measuring range

Typically $v = 0.01$ to 10 m/s (0.03 to 33 ft/s) with the specified accuracy

Electrical conductivity: ≥ 5 $\mu\text{S}/\text{cm}$ for liquids in general

Flow characteristic values in SI units: DN 25 to 125 mm (1 to 4 in)

Nominal diameter		Recommended flow min./max. full scale value ($v \sim 0.3 \dots 10$ m/s) [dm ³ /min]	Factory settings		
[mm]	[in]		Full scale value current output ($v \sim 2.5$ m/s) [dm ³ /min]	Pulse value (~ 2 Pulse/s at $v \sim 2.5$ m/s) [dm ³]	Low flow cut off ($v \sim 0.04$ m/s) [dm ³ /min]
25	1	9 to 300	75	0.5	1
32	-	15 to 500	125	1	2

Nominal diameter		Recommended flow min./max. full scale value (v ~ 0.3...10 m/s)	Factory settings		
[mm]	[in]		Full scale value current output (v ~ 2.5 m/s)	Pulse value (~ 2 Pulse/s at v ~ 2.5 m/s)	Low flow cut off (v ~ 0.04 m/s)
		[dm ³ /min]	[dm ³ /min]	[dm ³]	[dm ³ /min]
40	1 ½	25 to 700	200	1.5	3
50	2	35 to 1100	300	2.5	5
65	–	60 to 2 000	500	5	8
80	3	90 to 3 000	750	5	12
100	4	145 to 4 700	1200	10	20
125	–	220 to 7 500	1850	15	30

Flow characteristic values in SI units: DN 150 to 3 000 mm (6 to 120 in)

Nominal diameter		Recommended flow min./max. full scale value (v ~ 0.3...10 m/s)	Factory settings		
[mm]	[in]		Full scale value current output (v ~ 2.5 m/s)	Pulse value (~ 2 Pulse/s at v ~ 2.5 m/s)	Low flow cut off (v ~ 0.04 m/s)
		[m ³ /h]	[m ³ /h]	[m ³]	[m ³ /h]
150	6	20 to 600	150	0.025	2.5
200	8	35 to 1100	300	0.05	5
250	10	55 to 1700	500	0.05	7.5
300	12	80 to 2 400	750	0.1	10
350	14	110 to 3 300	1000	0.1	15
375	15	140 to 4 200	1200	0.15	20
400	16	140 to 4 200	1200	0.15	20
450	18	180 to 5 400	1500	0.25	25
500	20	220 to 6 600	2000	0.25	30
600	24	310 to 9 600	2 500	0.3	40
700	28	420 to 13 500	3 500	0.5	50
750	30	480 to 15 000	4000	0.5	60
800	32	550 to 18 000	4 500	0.75	75
900	36	690 to 22 500	6000	0.75	100
1000	40	850 to 28 000	7000	1	125
–	42	950 to 30 000	8000	1	125
1200	48	1 250 to 40 000	10 000	1.5	150
–	54	1 550 to 50 000	13 000	1.5	200
1400	–	1 700 to 55 000	14 000	2	225
–	60	1 950 to 60 000	16 000	2	250
1600	–	2 200 to 70 000	18 000	2.5	300
–	66	2 500 to 80 000	20 500	2.5	325
1800	72	2 800 to 90 000	23 000	3	350
–	78	3 300 to 100 000	28 500	3.5	450
2000	–	3 400 to 110 000	28 500	3.5	450

Nominal diameter		Recommended flow min./max. full scale value (v ~ 0.3...10 m/s)	Factory settings		
[mm]	[in]		Full scale value current output (v ~ 2.5 m/s) [m ³ /h]	Pulse value (~ 2 Pulse/s at v ~ 2.5 m/s) [m ³]	Low flow cut off (v ~ 0.04 m/s) [m ³ /h]
-	84	3 700 to 125 000	31 000	4.5	500
2200	-	4 100 to 136 000	34 000	4.5	540
-	90	4 300 to 143 000	36 000	5	570
2400	-	4 800 to 162 000	40 000	5.5	650
-	96	5 000 to 168 000	42 000	6	675
-	102	5 700 to 190 000	47 500	7	750
2600	-	5 700 to 191 000	48 000	7	775
-	108	6 500 to 210 000	55 000	7	850
2800	-	6 700 to 222 000	55 500	8	875
-	114	7 100 to 237 000	59 500	8	950
3000	-	7 600 to 254 000	63 500	9	1 025
-	120	7 900 to 263 000	65 500	9	1 050

Flow characteristic values in SI units: DN 50 to 200 mm (2 to 8 in) for order code for "Design", option C "Fixed flange, constricted measuring tube, 0 x DN inlet/outlet runs"

Nominal diameter		Recommended flow min./max. full scale value (v ~ 0.12...5 m/s)	Factory settings		
[mm]	[in]		Full scale value current output (v ~ 2.5 m/s) [dm ³ /min]	Pulse value (~ 4 Pulse/s at v ~ 2.5 m/s) [dm ³]	Low flow cut off (v ~ 0.01 m/s) [dm ³ /min]
50	2	15 to 600	300	1.25	1.25
65	-	25 to 1 000	500	2	2
80	3	35 to 1 500	750	3	3.25
100	4	60 to 2 400	1 200	5	4.75
125	-	90 to 3 700	1 850	8	7.5
150	6	145 to 5 400	2 500	10	11
200	8	220 to 9 400	5 000	20	19

Flow characteristic values in SI units: DN 250 to 300 mm (10 to 12 in) for order code for "Design", option C "Fixed flange, constricted measuring tube, 0 x DN inlet/outlet runs"

Nominal diameter		Recommended flow min./max. full scale value (v ~ 0.12...5 m/s)	Factory settings		
[mm]	[in]		Full scale value current output (v ~ 2.5 m/s) [m ³ /h]	Pulse value (~ 4 Pulse/s at v ~ 2.5 m/s) [m ³]	Low flow cut off (v ~ 0.01 m/s) [m ³ /h]
250	10	20 to 850	500	0.03	1.75
300	12	35 to 1 300	750	0.05	2.75

Flow characteristic values in US units: DN 1 to 48 in (25 to 1200 mm)

Nominal diameter		Recommended flow min./max. full scale value (v ~ 0.3...10 m/s) [gal/min]	Factory settings		
[in]	[mm]		Full scale value current output (v ~ 2.5 m/s) [gal/min]	Pulse value (~ 2 Pulse/s at v ~ 2.5 m/s) [gal]	Low flow cut off (v ~ 0.04 m/s) [gal/min]
1	25	2.5 to 80	18	0.2	0.25
-	32	4 to 130	30	0.2	0.5
1 ½	40	7 to 185	50	0.5	0.75
2	50	10 to 300	75	0.5	1.25
-	65	16 to 500	130	1	2
3	80	24 to 800	200	2	2.5
4	100	40 to 1250	300	2	4
-	125	60 to 1950	450	5	7
6	150	90 to 2650	600	5	12
8	200	155 to 4850	1200	10	15
10	250	250 to 7500	1500	15	30
12	300	350 to 10600	2400	25	45
14	350	500 to 15000	3600	30	60
15	375	600 to 19000	4800	50	60
16	400	600 to 19000	4800	50	60
18	450	800 to 24000	6000	50	90
20	500	1000 to 30000	7500	75	120
24	600	1400 to 44000	10500	100	180
28	700	1900 to 60000	13500	125	210
30	750	2150 to 67000	16500	150	270
32	800	2450 to 80000	19500	200	300
36	900	3100 to 100000	24000	225	360
40	1000	3800 to 125000	30000	250	480
42	-	4200 to 135000	33000	250	600
48	1200	5500 to 175000	42000	400	600

Flow characteristic values in US units: DN 54 to 120 in (1400 to 3000 mm)



Nominal diameter		Recommended flow min./max. full scale value (v ~ 0.3...10 m/s) [Mgal/d]	Factory settings		
[in]	[mm]		Full scale value current output (v ~ 2.5 m/s) [Mgal/d]	Pulse value (~ 2 Pulse/s at v ~ 2.5 m/s) [Mgal]	Low flow cut off (v ~ 0.04 m/s) [Mgal/d]
54	-	9 to 300	75	0.0005	1.3
-	1400	10 to 340	85	0.0005	1.3
60	-	12 to 380	95	0.0005	1.3
-	1600	13 to 450	110	0.0008	1.7
66	-	14 to 500	120	0.0008	2.2
72	1800	16 to 570	140	0.0008	2.6

Nominal diameter		Recommended flow min./max. full scale value (v ~ 0.3...10 m/s) [Mgal/d]	Factory settings		
[in]	[mm]		Full scale value current output (v ~ 2.5 m/s) [Mgal/d]	Pulse value (~ 2 Pulse/s at v ~ 2.5 m/s) [Mgal]	Low flow cut off (v ~ 0.04 m/s) [Mgal/d]
78	-	18 to 650	175	0.0010	3.0
-	2000	20 to 700	175	0.0010	2.9
84	-	24 to 800	190	0.0011	3.2
-	2200	26 to 870	210	0.0012	3.4
90	-	27 to 910	220	0.0013	3.6
-	2400	31 to 1030	245	0.0014	4.0
96	-	32 to 1066	265	0.0015	4.0
102	-	34 to 1203	300	0.0017	5.0
-	2600	34 to 1212	305	0.0018	5.0
108	-	35 to 1300	340	0.0020	5.0
-	2800	42 to 1405	350	0.0020	6.0
114	-	45 to 1503	375	0.0022	6.0
-	3000	48 to 1613	405	0.0023	6.0
120	-	50 to 1665	415	0.0024	7.0

Flow characteristic values in US units: DN 2 to 12 in (50 to 300 mm) for order code for "Design", option C "Fixed flange, constricted measuring tube, 0 x DN inlet/outlet runs"

Nominal diameter		Recommended flow min./max. full scale value (v ~ 0.12...5 m/s) [gal/min]	Factory settings		
[in]	[mm]		Full scale value current output (v ~ 2.5 m/s) [gal/min]	Pulse value (~ 4 Pulse/s at v ~ 2.5 m/s) [gal]	Low flow cut off (v ~ 0.01 m/s) [gal/min]
2	50	4 to 160	75	0.3	0.35
-	65	7 to 260	130	0.5	0.6
3	80	10 to 400	200	0.8	0.8
4	100	16 to 650	300	1.2	1.25
-	125	24 to 1000	450	1.8	2
6	150	40 to 1400	600	2.5	3
8	200	60 to 2500	1200	5	5
10	250	90 to 3700	1500	6	8
12	300	155 to 5700	2400	9	12

Recommended measuring range

 Flow limit →  52

 For custody transfer, the applicable approval determines the permitted measuring range, the pulse value and the low flow cut off.



Operable flow range

Over 1000 : 1

 For custody transfer, the operable flow range is 100 : 1 to 630 : 1, depending on the nominal diameter. Further details are specified by the applicable approval.

Input signal

External measured values

 Various pressure transmitters and temperature measuring devices can be ordered from Endress +Hauser: see "Accessories" section →  105

It is recommended to read in external measured values to calculate the following measured variables:
Mass flow

HART protocol

The measured values are written from the automation system to the measuring device via the HART protocol. The pressure transmitter must support the following protocol-specific functions:

- HART protocol
- Burst mode

Digital communication

The measured values can be written from the automation system to the measuring via:

- PROFIBUS DP
- Modbus RS485
- EtherNet/IP

Status input

Maximum input values	<ul style="list-style-type: none"> ■ DC 30 V ■ 6 mA
Response time	Configurable: 5 to 200 ms
Input signal level	<ul style="list-style-type: none"> ■ Low signal (low): DC -3 to +5 V ■ High signal (high): DC 12 to 30 V
Assignable functions	<ul style="list-style-type: none"> ■ Off ■ Reset totalizers 1-3 separately ■ Reset all totalizers ■ Flow override

Output

Output signal

Current output

Current output	Can be set as: <ul style="list-style-type: none"> ■ 4 to 20 mA NAMUR ■ 4 to 20 mA US ■ 4 to 20 mA HART ■ 0 to 20 mA
Maximum output values	<ul style="list-style-type: none"> ■ DC 24 V (no flow) ■ 22.5 mA
Load	0 to 700 Ω
Resolution	0.5 μA

Damping	Configurable: 0.07 to 999 s
Assignable measured variables	<ul style="list-style-type: none"> ▪ Volume flow ▪ Mass flow ▪ Corrected volume flow ▪ Flow velocity ▪ Conductivity ¹⁾ ▪ Corrected conductivity ¹⁾ ▪ Temperature ¹⁾ ▪ Electronics temperature ▪ Reference electrode potential ¹⁾ ▪ Coil current rise time ¹⁾ ▪ Noise ¹⁾ ▪ Build-up measured value ¹⁾ ▪ Test points 1-3

1) Visible depending on order options or device settings

Pulse/frequency/switch output

Function	<ul style="list-style-type: none"> ▪ With the order code for "Output; Input", option H: output 2 can be set as a pulse or frequency output ▪ With the order code for "Output; Input", option I: output 2 and 3 can be set as a pulse, frequency or switch output ▪ With the order code for "Output; Input", option J: output 2 firmly assigned as certified pulse output
Version	Passive, open collector
Maximum input values	<ul style="list-style-type: none"> ▪ DC 30 V ▪ 250 mA
Voltage drop	At 25 mA: ≤ DC 2 V
Pulse output	
Pulse width	Configurable: 0.05 to 2 000 ms
Maximum pulse rate	10 000 Impulse/s
Pulse value	Configurable
Assignable measured variables	<ul style="list-style-type: none"> ▪ Volume flow ▪ Mass flow ▪ Corrected volume flow
Frequency output	
Output frequency	Configurable: 0 to 12 500 Hz
Damping	Configurable: 0 to 999 s
Pulse/pause ratio	1:1
Assignable measured variables	<ul style="list-style-type: none"> ▪ Volume flow ▪ Mass flow ▪ Corrected volume flow ▪ Flow velocity ▪ Conductivity ¹⁾ ▪ Corrected conductivity ¹⁾ ▪ Temperature ¹⁾ ▪ Electronics temperature ▪ Noise ¹⁾ ▪ Coil current rise time ¹⁾ ▪ Reference electrode potential ¹⁾ ▪ Build-up measured value ¹⁾ ▪ Test points 1-3
Switch output	
Switching behavior	Binary, conductive or non-conductive
Switching delay	Configurable: 0 to 100 s

Number of switching cycles	Unlimited
Assignable functions	<ul style="list-style-type: none"> ▪ Off ▪ On ▪ Diagnostic behavior ▪ Limit value: <ul style="list-style-type: none"> ▪ Off ▪ Volume flow ▪ Corrected volume flow ▪ Mass flow ▪ Flow velocity ▪ Conductivity¹⁾ ▪ Corrected conductivity¹⁾ ▪ Totalizer 1-3 ▪ Temperature¹⁾ ▪ Electronics temperature ▪ Flow direction monitoring ▪ Status: <ul style="list-style-type: none"> ▪ Empty pipe detection ▪ Low flow cut off ▪ Build-up limit value¹⁾

1) Visible depending on order options or device settings

PROFIBUS DP

Signal encoding	NRZ code
Data transmission	9.6 kBaud...12 MBaud

Modbus RS485

Physical interface	In accordance with EIA/TIA-485-A standard
Terminating resistor	Integrated, can be activated via DIP switch on the transmitter electronics module

EtherNet/IP

Standards	In accordance with IEEE 802.3
------------------	-------------------------------

Signal on alarm

Depending on the interface, failure information is displayed as follows:

Current output 4 to 20 mA

4 to 20 mA

Failure mode	<p>Choose from:</p> <ul style="list-style-type: none"> ▪ 4 to 20 mA in accordance with NAMUR recommendation NE 43 ▪ 4 to 20 mA in accordance with US ▪ Min. value: 3.59 mA ▪ Max. value: 22.5 mA ▪ Freely definable value between: 3.59 to 22.5 mA ▪ Actual value ▪ Last valid value
---------------------	-----------------------------------------------------------------------------------------------------------------------------------------------------------------------------------------------------------------------------------------------------------------------------------------------------------------------------------------------------------

0 to 20 mA

Failure mode	<p>Choose from:</p> <ul style="list-style-type: none"> ▪ Maximum alarm: 22 mA ▪ Freely definable value between: 0 to 22.5 mA
---------------------	------------------------------------------------------------------------------------------------------------------------------------------------------

HART current output

Device diagnostics	Device condition can be read out via HART Command 48
--------------------	------------------------------------------------------

Pulse/frequency/switch output

Pulse output	
Failure mode	Choose from: <ul style="list-style-type: none"> ▪ Actual value ▪ No pulses
Frequency output	
Failure mode	Choose from: <ul style="list-style-type: none"> ▪ Actual value ▪ 0 Hz ▪ Defined value: 0 to 12 500 Hz
Switch output	
Failure mode	Choose from: <ul style="list-style-type: none"> ▪ Current status ▪ Open ▪ Closed

PROFIBUS DP

Status and alarm messages	Diagnostics in accordance with PROFIBUS PA Profile 3.02
---------------------------	---------------------------------------------------------

Modbus RS485

Failure mode	Choose from: <ul style="list-style-type: none"> ▪ NaN value instead of current value ▪ Last valid value
--------------	---------------------------------------------------------------------------------------------------------------------------------

EtherNet/IP

Device diagnostics	Device condition can be read out in Input Assembly
--------------------	----------------------------------------------------

Local display

Plain text display	With information on cause and remedial measures
Backlight	Red backlighting indicates a device error.





Status signal as per NAMUR recommendation NE 107

Interface/protocol

- Via digital communication:
 - HART protocol
 - PROFIBUS DP
 - Modbus RS485
 - EtherNet/IP
- Via service interface
 - CDI-RJ45 service interface
 - WLAN interface

Plain text display	With information on cause and remedial measures
---------------------------	-------------------------------------------------

 Additional information on remote operation →  95

Web browser

Plain text display	With information on cause and remedial measures
---------------------------	-------------------------------------------------

Light emitting diodes (LED)

Status information	Status indicated by various light emitting diodes The following information is displayed depending on the device version: <ul style="list-style-type: none"> ▪ Supply voltage active ▪ Data transmission active ▪ Device alarm/error has occurred ▪ EtherNet/IP network available ▪ EtherNet/IP connection established
---------------------------	------------------------------------------------------------------------------------------------------------------------------------------------------------------------------------------------------------------------------------------------------------------------------------------------------------------------------------------------------------------------------

Low flow cut off The switch points for low flow cut off are user-selectable.

Galvanic isolation The following connections are galvanically isolated from each other:

- Inputs
- Outputs
- Power supply

Protocol-specific data

HART



Manufacturer ID	0x11
Device type ID	0x1169
HART protocol revision	7
Device description files (DTM, DD)	Information and files under: www.endress.com
HART load	Min. 250 Ω
Dynamic variables PV, SV, TV, QV	<ul style="list-style-type: none"> ▪ Read out the dynamic variables via HART command 3 ▪ The measured variables can be freely assigned to the dynamic variables
Device variables	<ul style="list-style-type: none"> ▪ Read out the device variables via HART command 9 ▪ The measured variables can be freely assigned ▪ A maximum of 8 device variables can be transmitted
System integration	Operating Instructions for the device →  106

PROFIBUS DP

Manufacturer ID	0x11
Ident number	0x1562
Profile version	3.02
Device description files (GSD, DTM, DD)	Information and files under: <ul style="list-style-type: none"> ▪ www.endress.com ▪ www.profibus.org
Output values	Output values (from the measuring device to the automation system) <ul style="list-style-type: none"> ▪ 4 Analog input ▪ 2 Digital input ▪ 3 Totalizer

Input values	Input values (from the automation system to the measuring device) <ul style="list-style-type: none"> ▪ 2 Analog output (fixed assignment) ▪ 2 Digital output (fixed assignment) ▪ 3 Totalizer
Device address configuration options	Configuration of the device address <ul style="list-style-type: none"> ▪ Hardware: DIP switches on the I/O electronics module ▪ Software: Via operating tools (e.g. FieldCare)
Supported functions	<ul style="list-style-type: none"> ▪ Identification & Maintenance: Simplest device identification on the part of the control system and nameplate ▪ PROFIBUS upload/download: Reading and writing parameters is up to ten times faster with PROFIBUS upload/download ▪ Condensed status: Simplest and self-explanatory diagnostic information by categorizing diagnostic messages that occur
System integration	Operating Instructions for the device →  106

Modbus RS485

Protocol	Modbus Applications Protocol Specification V1.1
Device type	Slave
Slave address range	1 to 247
Broadcast address range	0
Function codes	<ul style="list-style-type: none"> ▪ 03: Read holding register ▪ 04: Read input register ▪ 06: Write single registers ▪ 08: Diagnostics ▪ 16: Write multiple registers ▪ 23: Read/write multiple registers
Broadcast messages	Supported by the following function codes: <ul style="list-style-type: none"> ▪ 06: Write single registers ▪ 16: Write multiple registers ▪ 23: Read/write multiple registers
Supported baud rate	<ul style="list-style-type: none"> ▪ 1 200 BAUD ▪ 2 400 BAUD ▪ 4 800 BAUD ▪ 9 600 BAUD ▪ 19 200 BAUD ▪ 38 400 BAUD ▪ 57 600 BAUD ▪ 115 200 BAUD
Modus data transmission	<ul style="list-style-type: none"> ▪ ASCII ▪ RTU
Data access	Each device parameter can be accessed via Modbus RS485.  For detailed information on the "Modbus RS485 register information", see the Description of Device Parameters →  106
System integration	Operating Instructions for the device →  106

EtherNet/IP

Protocol	<ul style="list-style-type: none"> ▪ The CIP Networks Library Volume 1: Common Industrial Protocol ▪ The CIP Networks Library Volume 2: EtherNet/IP Adaptation of CIP
Communication type	<ul style="list-style-type: none"> ▪ 10Base-T ▪ 100Base-TX
Device profile	Generic device (product type: 0x2B)
Manufacturer ID	0x49E

Device type ID	0x1069
Baud rates	Automatic 10/100 Mbit with half-duplex and full-duplex detection
Polarity	Auto-polarity for automatic correction of crossed TxD and RxD pairs
Supported CIP connections	Max. 3 connections
Explicit connections	Max. 5 connections
I/O connections	Max. 6 connections (scanner)
Configuration options for measuring device	Configuration options for measuring device <ul style="list-style-type: none"> ▪ DIP switches on the electronics module for IP addressing ▪ Manufacturer-specific software (FieldCare) ▪ Custom Add-on Profile for Rockwell Automation control systems ▪ Web browser ▪ Electronic Data Sheet (EDS) integrated in the measuring device
EtherNet interface configuration options	Configuration of the EtherNet interface <ul style="list-style-type: none"> ▪ Speed: 10 MBit, 100 MBit, auto (factory setting) ▪ Duplex: half-duplex, full-duplex, auto (factory setting)
Device address configuration options	Configuration of the device address <ul style="list-style-type: none"> ▪ DIP switches on the electronics module for IP addressing (last octet) ▪ DHCP ▪ Manufacturer-specific software (FieldCare) ▪ Custom Add-on Profile for Rockwell Automation control systems ▪ Web browser ▪ EtherNet/IP tools, e.g. RSLinx (Rockwell Automation)
Device Level Ring (DLR)	No
Assembly	<ul style="list-style-type: none"> ▪ Legacy Input Assembly Fix (Assem 100) ▪ Legacy Input Assembly Configurable (Assem 101) ▪ Legacy Output Assembly Fix (Assem 102) ▪ Legacy Configuration Assembly (Assem 104) ▪ Input Assembly Fix (Assem 120) ▪ Input Assembly Configurable (Assem 121) ▪ Output Assembly Fix (Assem 122) ▪ Configuration Assembly (Assem 124) ▪ Volume Flow Extended Fix Input (Assem 126) ▪ Volume Flow Universal Fix Input (Assem 127) ▪ Dummy Output Assembly Fix (Assem 199)
Requested Packet Interval (RPI)	5 ms to 10 s (factory setting: 20 ms)
System integration	Operating Instructions for the device →  106

Power supply

Terminal assignment

Transmitter: 0 to 20 mA/4 to 20 mA HART

The sensor can be ordered with terminals.

Connection methods available		Possible options for order code "Electrical connection"
Outputs	Power supply	
Terminals	Terminals	<ul style="list-style-type: none"> ▪ Option A: coupling M20x1 ▪ Option B: thread M20x1 ▪ Option C: thread G ½" ▪ Option D: thread NPT ½"

Supply voltage

Order code "Power supply"	Terminal numbers	terminal voltage		Frequency range
Option L (wide range power unit)	1 (L+/L), 2 (L-/N)	DC 24 V	±25%	–
		AC 24 V	±25%	50/60 Hz, ±4 Hz
		AC 100 to 240 V	–15 to +10%	50/60 Hz, ±4 Hz

Signal transmission with current output 0 to 20 mA/4 to 20 mA HART and other outputs and inputs

Order code for "Output" and "Input"	Terminal numbers							
	Output 1		Output 2		Output 3		Input	
	26 (+)	27 (-)	24 (+)	25 (-)	22 (+)	23 (-)	20 (+)	21 (-)
Option H	Current output ▪ 4 to 20 mA HART (active) ▪ 0 to 20 mA (active)		Pulse/frequency output (passive)		Switch output (passive)		–	
Option I	Current output ▪ 4 to 20 mA HART (active) ▪ 0 to 20 mA (active)		Pulse/frequency/switch output (passive)		Pulse/frequency/switch output (passive)		Status input	
Option J	Current output ▪ 4 to 20 mA HART (active) ▪ 0 to 20 mA (active)		Fixed assignment: Certified pulse output (passive)		Switch output		Status input	

Transmitter: PROFIBUS DP

The sensor can be ordered with terminals.

Connection methods available		Possible options for order code "Electrical connection"
Outputs	Power supply	
Terminals	Terminals	<ul style="list-style-type: none"> ▪ Option A: coupling M20x1 ▪ Option B: thread M20x1 ▪ Option C: thread G ½" ▪ Option D: thread NPT ½"

Supply voltage

Order code "Power supply"	Terminal numbers	terminal voltage		Frequency range
Option L (wide range power unit)	1 (L+/L), 2 (L-/N)	DC 24 V	±25%	–
		AC 24 V	±25%	50/60 Hz, ±4 Hz
		AC 100 to 240 V	–15 to +10%	50/60 Hz, ±4 Hz

PROFIBUS DP signal transmission

Order code for "Output" and "Input"	Terminal numbers	
	26 (RxD/TxD-P)	27 (RxD/TxD-N)
Option L	B	A
Order code for "Output": Option L: PROFIBUS DP, for use in non-hazardous areas and Zone 2/Div. 2		

Transmitter: Modbus RS485

The sensor can be ordered with terminals.

Connection methods available		Possible options for order code "Electrical connection"
Outputs	Power supply	
Terminals	Terminals	<ul style="list-style-type: none"> ■ Option A: coupling M20x1 ■ Option B: thread M20x1 ■ Option C: thread G ½" ■ Option D: thread NPT ½"

Supply voltage

Order code "Power supply"	Terminal numbers	terminal voltage		Frequency range
Option L (wide range power unit)	1 (L+/L), 2 (L-/N)	DC 24 V	±25%	–
		AC 24 V	±25%	50/60 Hz, ±4 Hz
		AC 100 to 240 V	–15 to +10%	50/60 Hz, ±4 Hz

Signal transmission with Modbus RS485 and other outputs

Order code for "Output" and "Input"	Terminal numbers							
	26 (+)	27 (-)	24 (+)	25 (-)	22 (+)	23 (-)	20 (+)	21 (-)
Option M	Modbus B A		-		-		-	
Option O	Current output 4 to 20 mA (active)		Pulse/frequency/ switch output (passive)		Pulse/frequency/ switch output (passive)		Modbus B A	
Option P	Current output 4 to 20 mA (active)		Pulse output certified (passive)		Pulse/frequency/ switch output (passive)		Modbus B A	

Transmitter: EtherNet/IP

The transmitter can be ordered with terminals or a device plug.

Connection methods available		Possible options for order code "Electrical connection"
Outputs	Power supply	
EtherNet/IP (RJ45 plug)	Terminals	Option D: thread NPT ½"
Device plug → 22	Terminals	<ul style="list-style-type: none"> ■ Option L: plug M12x1 + thread NPT ½" ■ Option N: plug M12x1 + coupling M20 ■ Option P: plug M12x1 + thread G ½" ■ Option U: plug M12x1 + thread M20

Supply voltage

Order code "Power supply"	Terminal numbers	terminal voltage		Frequency range
Option L (wide range power unit)	1 (L+/L), 2 (L-/N)	DC 24 V	±25%	–
		AC 24 V	±25%	50/60 Hz, ±4 Hz
		AC 100 to 240 V	–15 to +10%	50/60 Hz, ±4 Hz

EtherNet/IP signal transmission

Order code for "Output"	Connection via
Option N	EtherNet/IP: RJ45 or M12 plug

Remote version

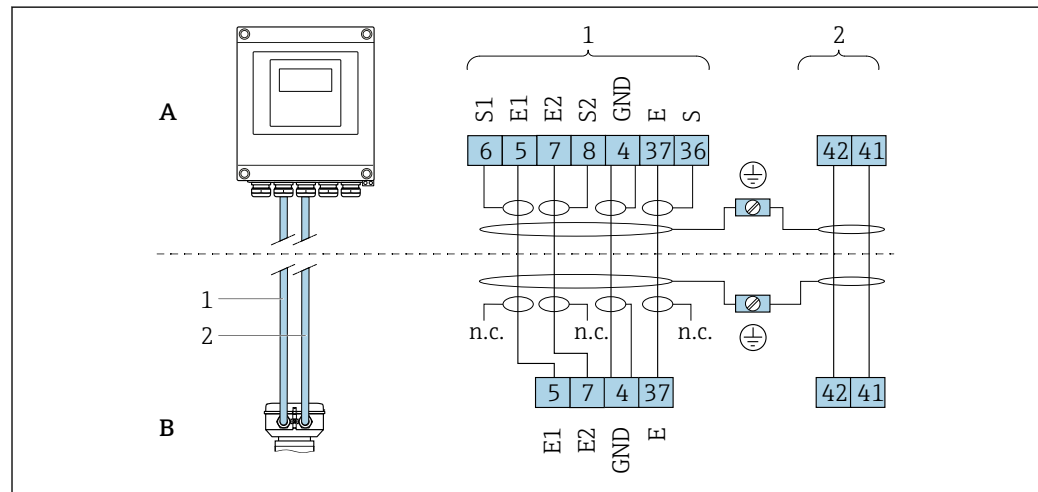

A0032059

2 Remote version terminal assignment

- A Transmitter wall-mount housing
- B Sensor connection housing
- 1 Electrode cable
- 2 Coil current cable
- n.c. Not connected, insulated cable shields

Terminal No. and cable colors: 6/5 = brown; 7/8 = white; 4 = green; 36/37 = yellow

Pin assignment, device plug

i Order codes for the M12x1 plugs, see the "Order code for electrical connection" column: EtherNet/IP → 21

EtherNet/IP

Device plug for signal transmission (device side)

Pin	Assignment		Coding	Plug/socket
	+	-		
1	Tx		D	Socket
2	Rx			
3		Tx		
4		Rx		

- i** Recommended plug:
- Binder, series 763, part no. 99 3729 810 04
 - Phoenix, part no. 1543223 SACC-M12MSD-4Q
 - The device plug is not permitted in the hazardous area, Class I Division 2. The device plug may only be used in the non-hazardous area (General Purpose).

Supply voltage

Transmitter

Order code for "Power supply"	terminal voltage		Frequency range
Option L	DC 24 V	±25%	–
	AC 24 V	±25%	50/60 Hz, ±4 Hz
	AC 100 to 240 V	–15 to +10%	50/60 Hz, ±4 Hz

Power consumption

Order code for "Output"	Maximum power consumption
Option H: 4-20mA HART, pulse/frequency output, switch output	30 VA/8 W
Option I: 4-20mA HART, 2 x pulse/frequency/switch output, status input	30 VA/8 W
Option J: 4-20mA HART, certified pulse output, switch output, status input	30 VA/8 W
Option L: PROFIBUS DP	30 VA/8 W
Option M: Modbus RS485	30 VA/8 W
Option O: Modbus RS485, 4-20mA, 2 x pulse/frequency/switch output	30 VA/8 W
Option P: Modbus RS485, 4-20mA, certified pulse output, pulse/frequency/switch output	30 VA/8 W
Option N: EtherNet/IP	30 VA/8 W

Current consumption

Transmitter

Order code for "Power supply"	Maximum Current consumption	Maximum switch-on current
Option L: AC 100 to 240 V	145 mA	25 A (< 5 ms)
Option L: AC/DC 24 V	350 mA	27 A (< 5 ms)

Power supply failure

- Totalizers stop at the last value measured.
- Depending on the device version, the configuration is retained in the device memory or in the pluggable data memory (HistoROM DAT).
- Error messages (incl. total operated hours) are stored.

Electrical connection

Connecting the transmitter

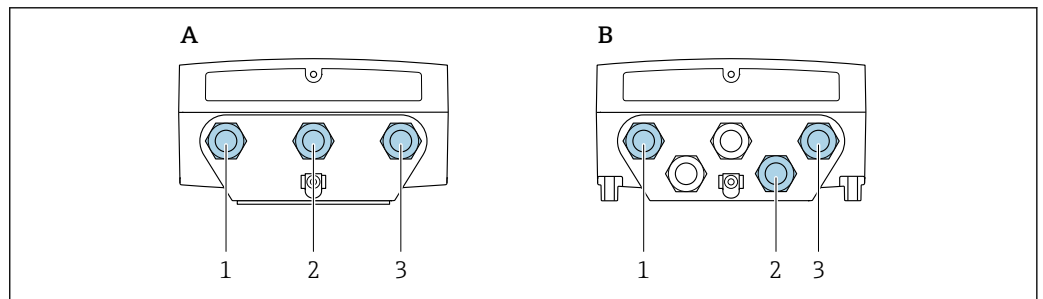

3 Supply voltage and signal transmission connection

- A Compact version
- B Remote version wall-mount housing
- 1 Cable entry for supply voltage
- 2 Cable entry for signal transmission
- 3 Cable entry for signal transmission

Remote version connection

Connecting cable

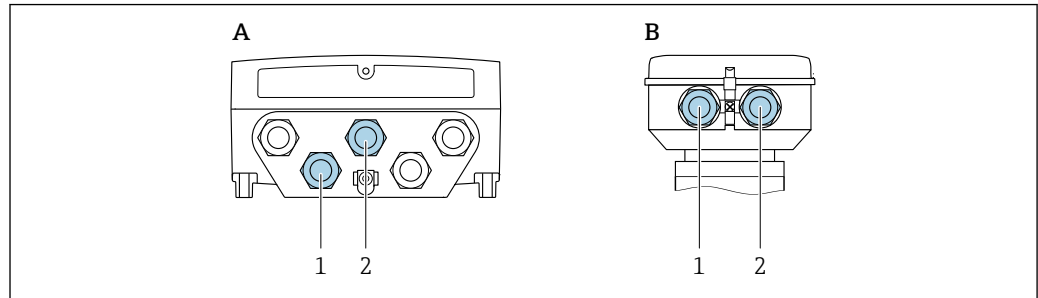

A0032042

4 Connecting cable connection: electrode and coil current cable

- A Transmitter wall-mount housing
 B Sensor connection housing
 1 Electrode cable
 2 Coil current cable

- Fix the cable run or route it in an armored conduit.
Cable movements can influence the measuring signal especially in the case of low fluid conductivities.
- Route the cable well clear of electrical machines and switching elements.
- Ensure potential equalization between the sensor and transmitter → 27.

Connection examples

Current output 4 to 20 mA HART

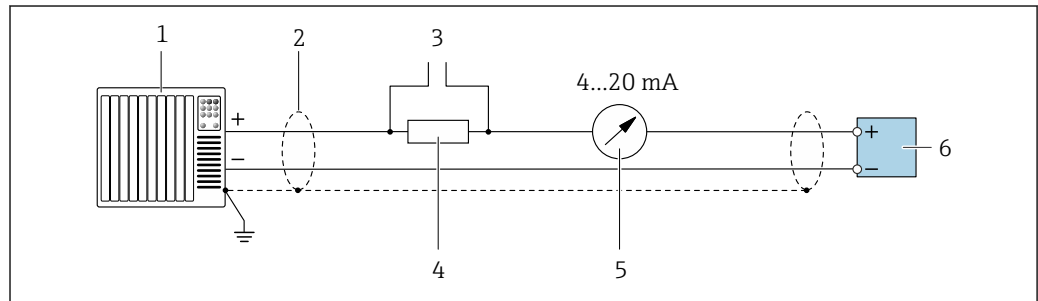

A0029055

5 Connection example for 4 to 20 mA HART current output (active)

- 1 Automation system with current input (e.g. PLC)
 2 Cable shield provided at one end. The cable shield must be grounded at both ends to comply with EMC requirements; observe cable specifications → 31
 3 Connection for HART operating devices → 95
 4 Resistor for HART communication ($\geq 250 \Omega$): observe maximum load → 13
 5 Analog display unit: observe maximum load → 13
 6 Transmitter

Current output 4 to 20 mA

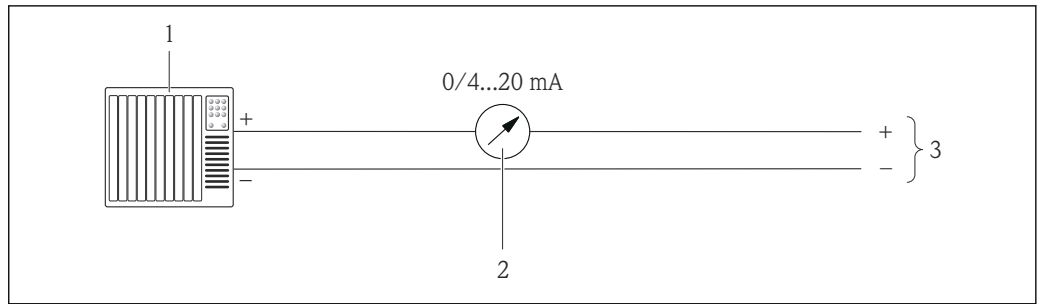

A0017162

6 Connection example for 0 to 20 mA (active) and 4 to 20 mA (active) current output

- 1 Automation system with current input (e.g. PLC)
- 2 Analog display unit: observe maximum load
- 3 Transmitter

Pulse/frequency output

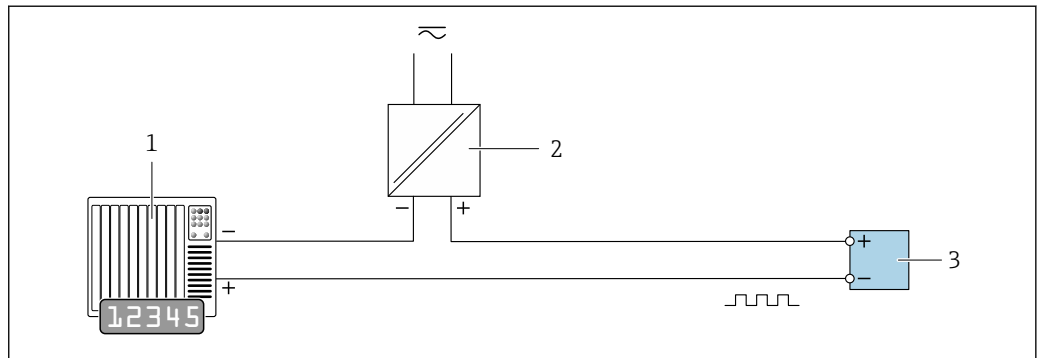

A0028761

7 Connection example for pulse/frequency output (passive)

- 1 Automation system with pulse/frequency input (e.g. PLC)
- 2 Power supply
- 3 Transmitter: Observe input values → 14

Switch output

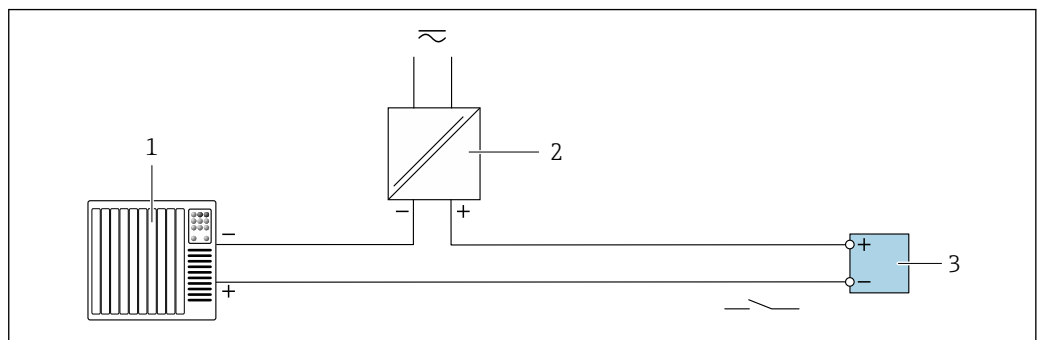

A0028760

8 Connection example for switch output (passive)

- 1 Automation system with switch input (e.g. PLC)
- 2 Power supply
- 3 Transmitter: Observe input values → 14

PROFIBUS DP

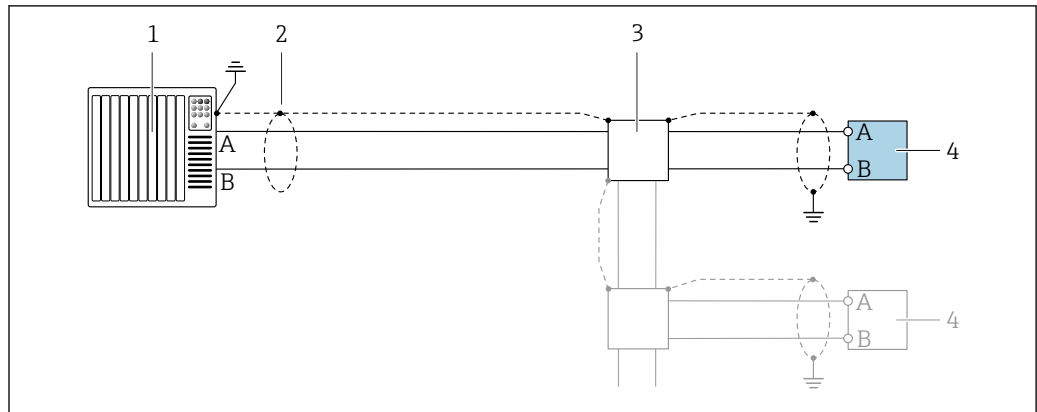

A0028765

9 Connection example for PROFIBUS DP, non-hazardous area and Zone 2/Div. 2

- 1 Control system (e.g. PLC)
- 2 Cable shield provided at one end. The cable shield must be grounded at both ends to comply with EMC requirements; observe cable specifications
- 3 Distribution box
- 4 Transmitter

i If baud rates > 1.5 MBaud an EMC cable entry must be used and the cable shield must continue as far as the terminal wherever possible.

Modbus RS485

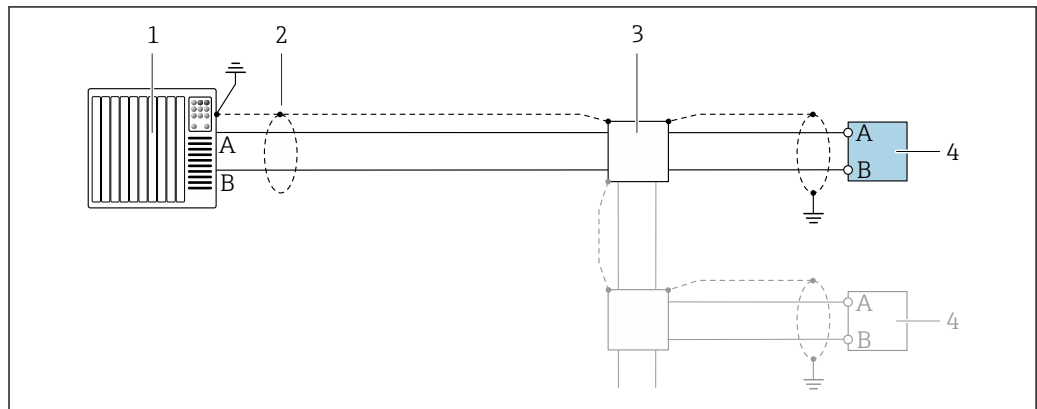

A0028765

10 Connection example for Modbus RS485, non-hazardous area and Zone 2/Div. 2

- 1 Control system (e.g. PLC)
- 2 Cable shield provided at one end. The cable shield must be grounded at both ends to comply with EMC requirements; observe cable specifications
- 3 Distribution box
- 4 Transmitter

EtherNet/IP

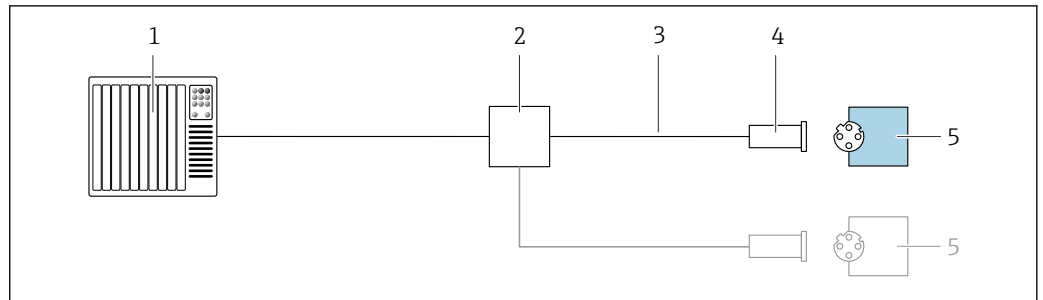

A0028767

11 Connection example for EtherNet/IP

- 1 Control system (e.g. PLC)
- 2 Ethernet switch
- 3 Observe cable specifications
- 4 Device plug
- 5 Transmitter

Status input

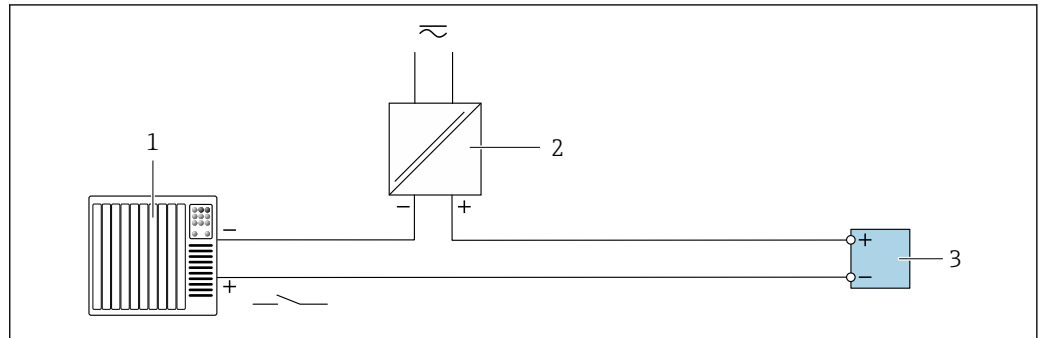

A0028764

12 Connection example for status input

- 1 Automation system with status output (e.g. PLC)
- 2 Power supply
- 3 Transmitter



Potential equalization

Introduction

Correct potential equalization (equipotential bonding) is a prerequisite for stable and reliable flow measurement. Inadequate or incorrect potential equalization can result in device failure and present a safety hazard.

The following requirements must be observed to ensure correct, trouble-free measurement:

- The principle that the medium, the sensor and the transmitter must be at the same electrical potential applies.
- Take in-company grounding guidelines, materials and the grounding conditions and potential conditions of the pipe into consideration.
- Any necessary potential equalization connections must be established by ground cables with a minimum cross-section of 6 mm² (0.0093 in²).
- For remote device versions, the ground terminal in the example always refers to the sensor and not to the transmitter.

 You can order accessories like ground cables and ground disks from Endress+Hauser →  103

 For devices intended for use in hazardous locations, observe the instructions in the Ex documentation (XA).

Abbreviations used

- PE (Protective Earth): potential at the protective earth terminals of the device
- P_P (Potential Pipe): potential of the pipe, measured at the flanges
- P_M (Potential Medium): potential of the medium

Connection examples for standard situations

Unlined and grounded metal pipe

- Potential equalization is via the measuring pipe.
- The medium is set to ground potential.

Starting conditions:

- Pipes are correctly grounded on both sides.
- Pipes are conductive and at the same electrical potential as the medium

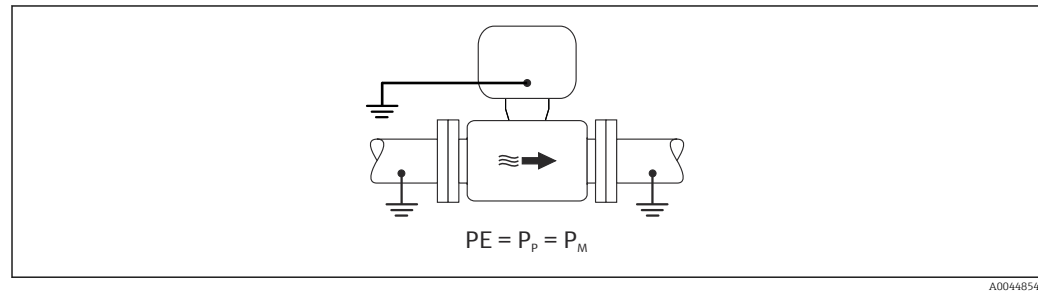

- ▶ Connect the connection housing of the transmitter or sensor to ground potential by means of the ground terminal provided for this purpose.

Unlined metal pipe

- Potential equalization is via the ground terminal and pipe flanges.
- The medium is set to ground potential.

Starting conditions:

- Pipes are not sufficiently grounded.
- Pipes are conductive and at the same electrical potential as the medium

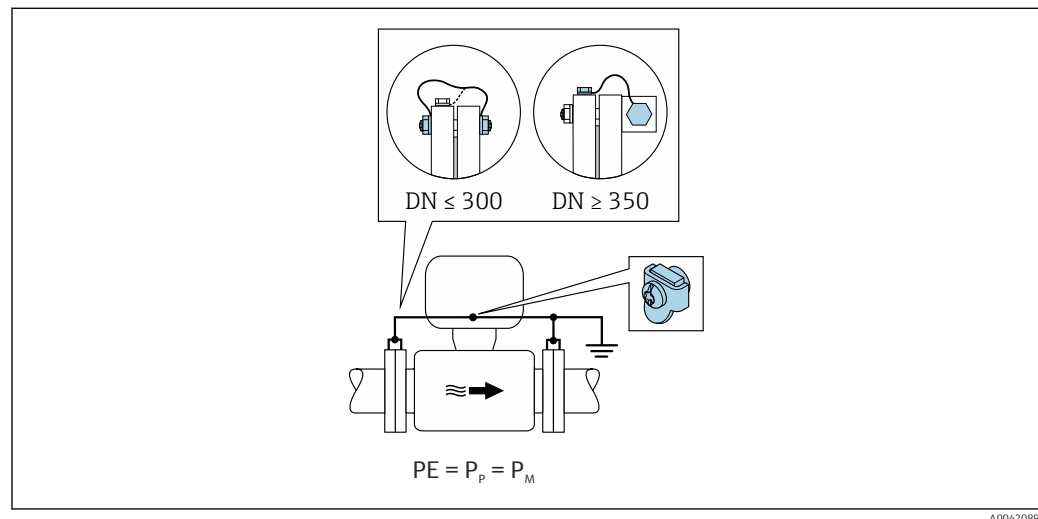

1. Connect both sensor flanges to the pipe flange via a ground cable and ground them.
2. Connect the connection housing of the transmitter or sensor to ground potential by means of the ground terminal provided for this purpose.

- i** ▪ For DN ≤ 300 (12"): Mount the ground cable directly on the conductive flange coating of the sensor with the flange screws.
- For DN ≥ 350 (14"): Mount the ground cable directly on the metal transport bracket. Observe screw tightening torques: see the Brief Operating Instructions for the sensor.

Plastic pipe or pipe with insulating liner

- Potential equalization is via the ground terminal and ground disks.
- The medium is set to ground potential.

Starting conditions:

- The pipe has an insulating effect.
- Low-impedance medium grounding close to the sensor is not guaranteed.
- Equalizing currents through the medium cannot be ruled out.

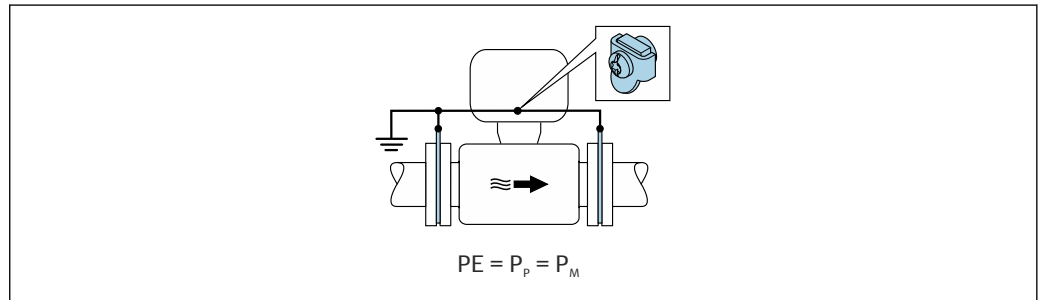

A0044856

1. Connect the ground disks to the ground terminal of the connection housing of the transmitter or sensor via the ground cable.
2. Connect the connection to ground potential.

Connection example with the potential of the medium not equal to the protective ground

In these cases, the medium potential can differ from the potential of the device.

Metal, ungrounded pipe

The sensor and transmitter are installed in a way that provides electrical insulation from PE, e.g. applications for electrolytic processes or systems with cathodic protection.

Starting conditions:

- Unlined metal pipe
- Pipes with an electrically conductive liner

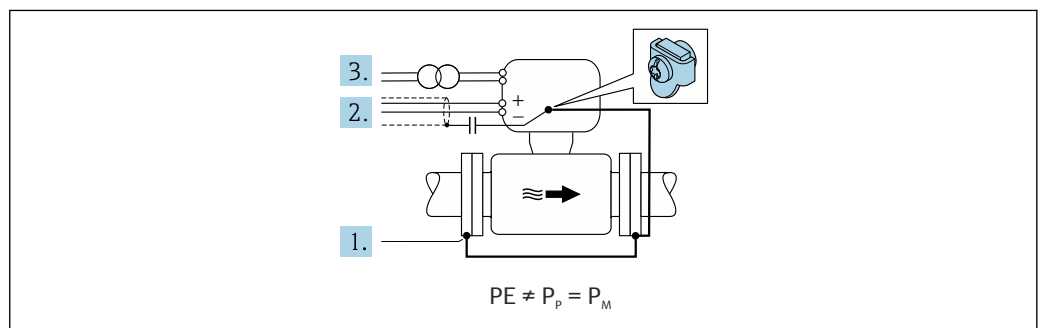

A0042253

1. Connect the pipe flanges and transmitter via the ground cable.
2. Route the shielding of the signal lines via a capacitor (recommended value $1.5\mu\text{F}/50\text{V}$).
3. Device connected to power supply such that it is floating in relation to the protective earth (isolation transformer). This measure is not required in the case of 24V DC supply voltage without PE (= SELV power unit).

Connection examples with the potential of medium not equal to protective earth with the "Measurement isolated from ground" option

In these cases, the medium potential can differ from the potential of the device.

Introduction

The "Measurement isolated from ground" option enables the galvanic isolation of the measuring system from the device potential. This minimizes harmful equalizing currents caused by differences

in potential between the medium and the device. The "Measurement isolated from ground" option is optionally available: order code for "Sensor option", option CV

Operating conditions for the use of the "Measurement isolated from ground" option

Device version	Compact version and remote version (length of connecting cable ≤ 10 m)
Differences in voltage between medium potential and device potential	As small as possible, usually in the mV range
Alternating voltage frequencies in the medium or at ground potential (PE)	Below typical power line frequency in the country

i To achieve the specified conductivity measuring accuracy, a conductivity calibration is recommended when the device is installed.

A full pipe adjustment is recommended when the device is installed.

Plastic pipe

Sensor and transmitter are correctly grounded. A difference in potential can occur between the medium and protective earth. Potential equalization between P_M and PE via the reference electrode is minimized with the "Measurement isolated from ground" option.

Starting conditions:

- The pipe has an insulating effect.
- Equalizing currents through the medium cannot be ruled out.

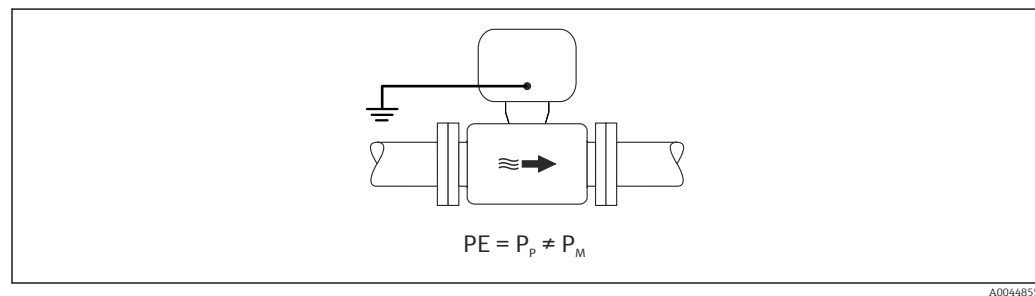

1. Use the "Measurement isolated from ground" option, while observing the operating conditions for measurement isolated from ground.
2. Connect the connection housing of the transmitter or sensor to ground potential by means of the ground terminal provided for this purpose.

Metal, ungrounded pipe with insulating liner

The sensor and transmitter are installed in a way that provides electrical insulation from PE. The medium and pipe have different potentials. The "Measurement isolated from ground" option minimizes harmful equalizing currents between P_M and P_p via the reference electrode.

Starting conditions:

- Metal pipe with insulating liner
- Equalizing currents through the medium cannot be ruled out.

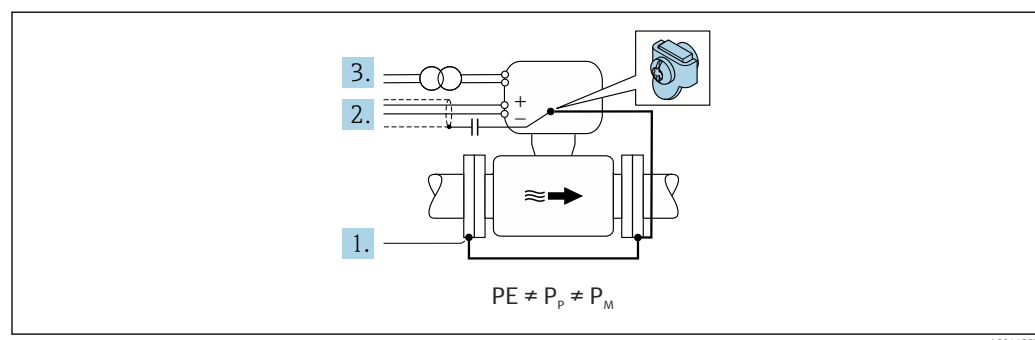

1. Connect the pipe flanges and transmitter via the ground cable.
2. Route the shielding of the signal cables via a capacitor (recommended value 1.5µF/50V).
3. Device connected to power supply such that it is floating in relation to the protective earth (isolation transformer). This measure is not required in the case of 24V DC supply voltage without PE (= SELV power unit).
4. Use the "Measurement isolated from ground" option, while observing the operating conditions for measurement isolated from ground.

Terminals

Transmitter

- Supply voltage cable: plug-in spring terminals for wire cross-sections 0.5 to 2.5 mm² (20 to 14 AWG)
- Signal cable: plug-in spring terminals for wire cross-sections 0.5 to 2.5 mm² (20 to 14 AWG)
- Electrode cable: spring terminals for wire cross-sections 0.5 to 2.5 mm² (20 to 14 AWG)
- Coil current cable: spring terminals for wire cross-sections 0.5 to 2.5 mm² (20 to 14 AWG)

Sensor connection housing

Spring terminals for wire cross-sections 0.5 to 2.5 mm² (20 to 14 AWG)

Cable entries

Cable entry thread

- M20 x 1.5
- Via adapter:
 - NPT ½"
 - G ½"

Cable gland

- For standard cable: M20 × 1.5 with cable ø 6 to 12 mm (0.24 to 0.47 in)
- For armored cable: M20 × 1.5 with cable ø 9.5 to 16 mm (0.37 to 0.63 in)

 If metal cable entries are used, use a grounding plate.

Cable specification

Permitted temperature range

- The installation guidelines that apply in the country of installation must be observed.
- The cables must be suitable for the minimum and maximum temperatures to be expected.

Power supply cable (incl. conductor for the inner ground terminal)

Standard installation cable is sufficient.

Signal cable

Current output 0/4 to 20 mA

Standard installation cable is sufficient.

Current output 4 to 20 mA HART

A shielded cable is recommended. Observe grounding concept of the plant.

Pulse/frequency/switch output

Standard installation cable is sufficient.

Status input

Standard installation cable is sufficient.

PROFIBUS DP

The IEC 61158 standard specifies two types of cable (A and B) for the bus line which can be used for every transmission rate. Cable type A is recommended.

Cable type	A
Characteristic impedance	135 to 165 Ω at a measuring frequency of 3 to 20 MHz
Cable capacitance	< 30 pF/m
Wire cross-section	> 0.34 mm ² (22 AWG)

Cable type	Twisted pairs
Loop resistance	$\leq 110 \Omega/\text{km}$
Signal damping	Max. 9 dB over the entire length of the cable cross-section
Shield	Copper braided shielding or braided shielding with foil shield. When grounding the cable shield, observe the grounding concept of the plant.



For further information on planning and installing PROFIBUS networks see:

Operating Instructions "PROFIBUS DP/PA: Guidelines for planning and commissioning" (BA00034S)

Modbus RS485

The EIA/TIA-485 standard specifies two types of cable (A and B) for the bus line which can be used for every transmission rate. Cable type A is recommended.

Cable type	A
Characteristic impedance	135 to 165 Ω at a measuring frequency of 3 to 20 MHz
Cable capacitance	< 30 pF/m
Wire cross-section	> 0.34 mm ² (22 AWG)
Cable type	Twisted pairs
Loop resistance	$\leq 110 \Omega/\text{km}$
Signal damping	Max. 9 dB over the entire length of the cable cross-section
Shield	Copper braided shielding or braided shielding with foil shield. When grounding the cable shield, observe the grounding concept of the plant.

EtherNet/IP

The standard ANSI/TIA/EIA-568-B.2 Annex specifies CAT 5 as the minimum category for a cable used for EtherNet/IP. CAT 5e and CAT 6 are recommended.



For more information on planning and installing EtherNet/IP networks, please refer to the "Media Planning and Installation Manual. EtherNet/IP" of ODVA Organization

Connecting cable for remote version

Electrode cable

Standard cable	3 \times 0.38 mm ² (20 AWG) with common, braided copper shield (ϕ ~9.5 mm (0.37 in)) and individual shielded cores
Cable for empty pipe detection (EPD)	4 \times 0.38 mm ² (20 AWG) with common, braided copper shield (ϕ ~9.5 mm (0.37 in)) and individual shielded cores
Conductor resistance	$\leq 50 \Omega/\text{km}$ (0.015 Ω/ft)
Capacitance: core/shield	$\leq 420 \text{ pF/m}$ (128 pF/ft)
Operating temperature	-20 to +80 °C (-4 to +176 °F)

Coil current cable

Standard cable	3 \times 0.75 mm ² (18 AWG) with common, braided copper shield (ϕ ~9 mm (0.35 in))
Conductor resistance	$\leq 37 \Omega/\text{km}$ (0.011 Ω/ft)
Capacitance: core/core, shield grounded	$\leq 120 \text{ pF/m}$ (37 pF/ft)

Operating temperature	-20 to +80 °C (-4 to +176 °F)
Test voltage for cable insulation	≤ AC 1433 V rms 50/60 Hz or ≥ DC 2026 V

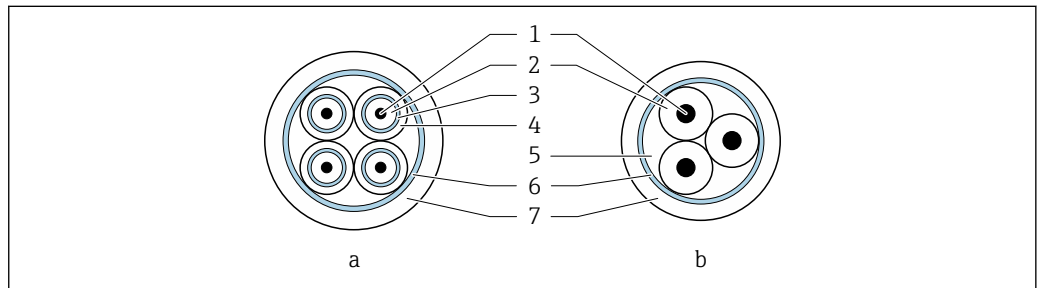

A0029151

13 Cable cross-section

- a Electrode cable
- b Coil current cable
- 1 Core
- 2 Core insulation
- 3 Core shield
- 4 Core jacket
- 5 Core reinforcement
- 6 Cable shield
- 7 Outer jacket

- i** A connecting cable can be ordered from Endress+Hauser for IP68:
 - Pre-terminated cables that are already connected to the sensor
 - Pre-terminated cables, where the cables are connected by the customer onsite (incl. tools for sealing the connection compartment)

Armored connecting cable

Armored connecting cables with an additional, reinforcing metal braid should be used:

- When laying the cable directly in the ground
- Where there is a risk of damage from rodents
- Use as per IP68 degree of protection

- i** Armored connecting cables with an additional, reinforcing metal braid can be ordered from Endress+Hauser → 103.

Operation in environments with strong electrical interference

The measuring system meets the general safety requirements → 102 and EMC specifications → 48.

Grounding is by means of the ground terminal provided for the purpose inside the connection housing. The stripped and twisted lengths of cable shield to the ground terminal must be as short as possible.

Performance characteristics

Reference operating conditions

- Error limits following DIN EN 29104, in future ISO 20456
- Water, typically +15 to +45 °C (+59 to +113 °F); 0.5 to 7 bar (73 to 101 psi)
- Data as indicated in the calibration protocol
- Accuracy based on accredited calibration rigs according to ISO 17025

Maximum measured error

Error limits under reference operating conditions

Volume flow

- ±0.5 % o.r. ± 1 mm/s (0.04 in/s)
- Optional: ±0.2 % o.r. ± 2 mm/s (0.08 in/s)

i Fluctuations in the supply voltage do not have any effect within the specified range.

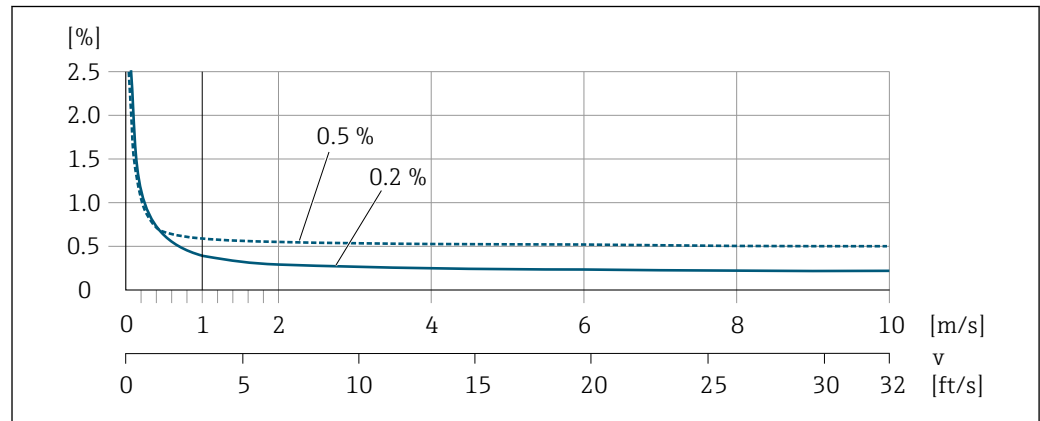

14 Maximum measured error in % o.r.

Flat Spec

For Flat Spec in the range $v_{0.5}$ ($v_{0.2}$) up to v_{max} the measured error is constant.

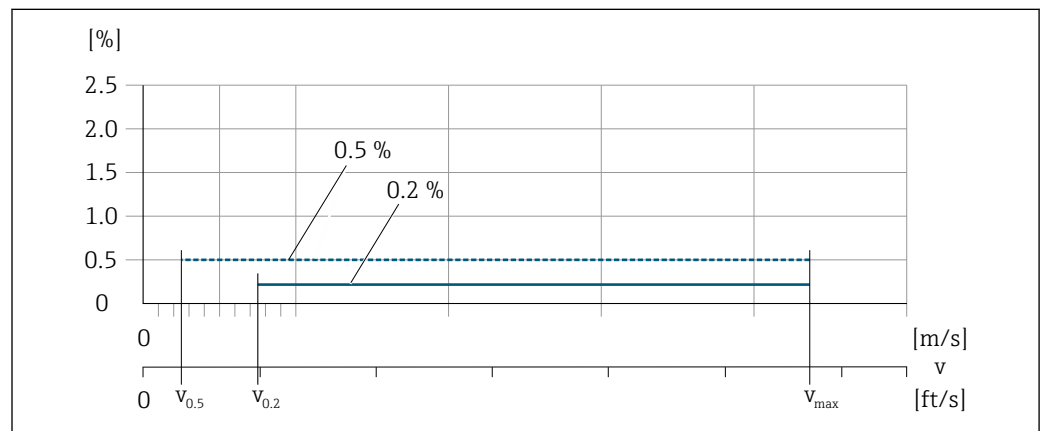

15 Flat Spec in % o.r.

Flat Spec flow values 0.5 %

Nominal diameter		$v_{0.5}$		v_{max}	
[mm]	[in]	[m/s]	[ft/s]	[m/s]	[ft/s]
25 to 600	1 to 24	0.5	1.64	10	32
50 to 300 ¹⁾	2 to 12	0.25	0.82	5	16

1) Order code for "Design", option C

Flat Spec flow values 0.2 %

Nominal diameter		v _{0.2}		v _{max}	
[mm]	[in]	[m/s]	[ft/s]	[m/s]	[ft/s]
25 to 600	1 to 24	1.5	4.92	10	32
50 to 300 ¹⁾	2 to 12	0.6	1.97	4	13

1) Order code for "Design", option C

Electrical conductivity

The values apply for:

- Measurements at a reference temperature of 25 °C (77 °F)
At different temperatures, attention must be paid to the temperature coefficient of the medium (typically 2.1 %/K)
- Device version: compact version - transmitter and sensor form a mechanical unit
- Devices installed in a metal pipe or in a non-metal pipe with ground disks
- Devices whose potential equalization was performed according to the instructions in the associated Operating Instructions

Conductivity [µS/cm]	Measured error [%] o. r.
5 to 20	± 20%
20 to 20 000	± 10%
20 000 to 100 000	± 20%

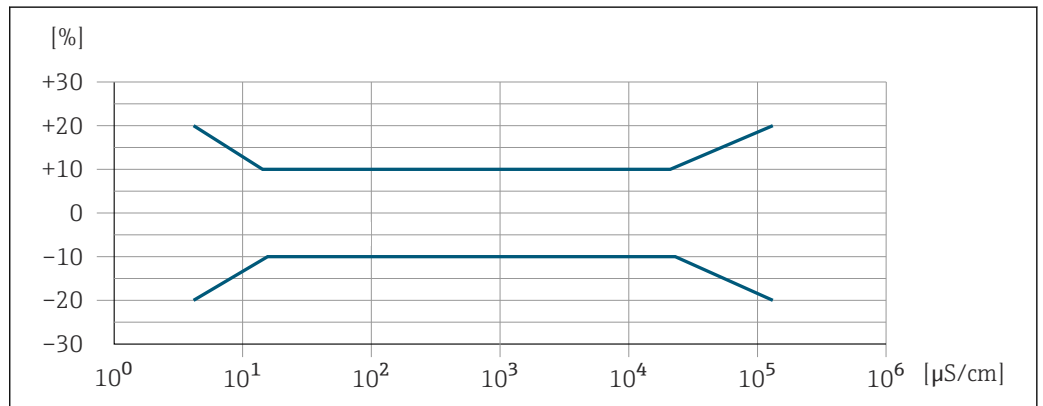

A0042279

16 Measured error

Accuracy of outputs

The outputs have the following base accuracy specifications.

Current output

Accuracy	Max. ±5 µA
----------	------------

Pulse/frequency output

o.r. = of reading

Accuracy	Max. ±50 ppm o.r. (over the entire ambient temperature range)
----------	---------------------------------------------------------------

Repeatability

o.r. = of reading

Volume flow

max. ±0.1 % o.r. ± 0.5 mm/s (0.02 in/s)

Electrical conductivityMax. ± 5 % o.r.**Influence of ambient temperature****Current output**

o.r. = of reading

Temperature coefficient	Max. ± 0.005 % o.r./°C
--------------------------------	----------------------------

Pulse/frequency output

Temperature coefficient	No additional effect. Included in accuracy.
--------------------------------	---------------------------------------------

Installation

Mounting location

- Do not install the device at the highest point of the pipe.
- Do not install the device upstream from a free pipe outlet in a down pipe.

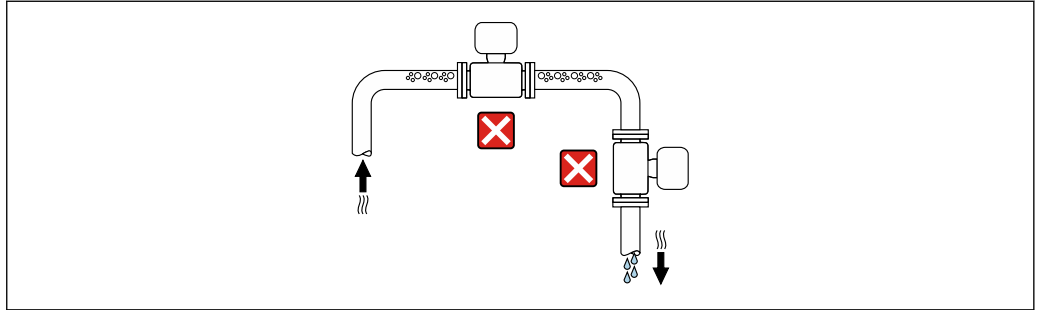

A0042131

The device should ideally be installed in an ascending pipe.

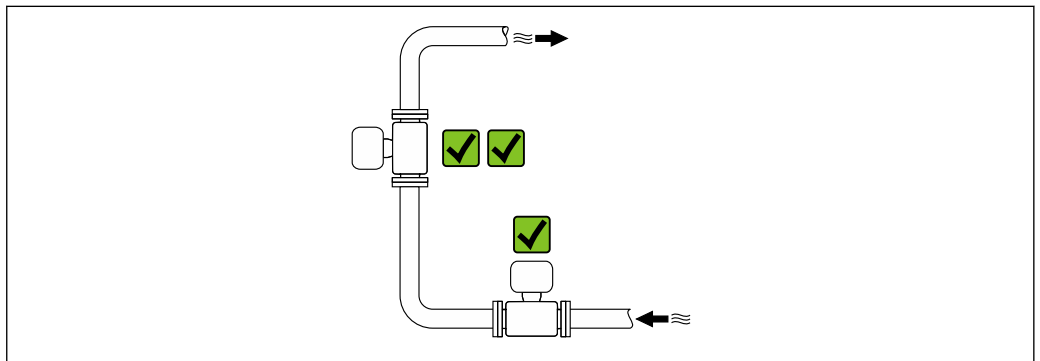

A0042317

Installation near valves

Install the device in the direction of flow upstream from the valve.

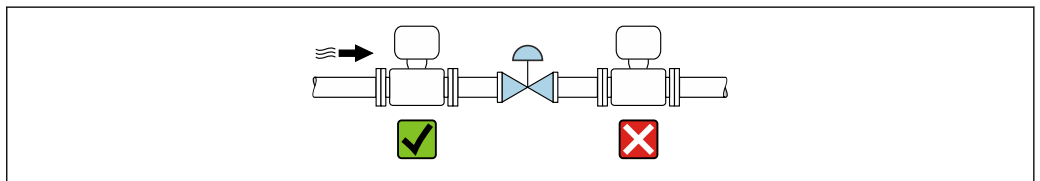

A0041091

Installation upstream from a down pipe

NOTICE

Negative pressure in the measuring pipe can damage the liner!

- If installing upstream from down pipes with a length $h \geq 5$ m (16.4 ft), install a siphon with a vent valve downstream from the device.

 This arrangement prevents the stoppage of liquid flow and the formation of air pockets.

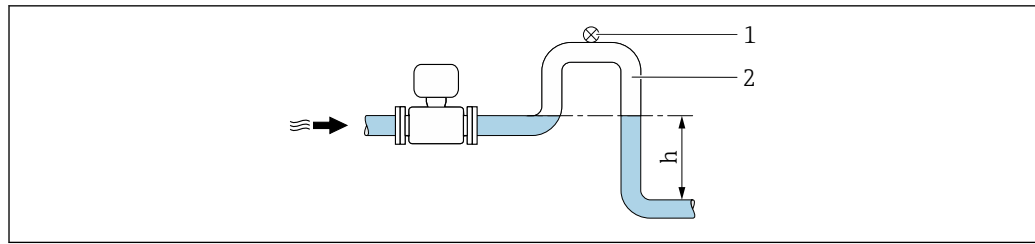

A0028961

- 1 Vent valve
2 Pipe siphon
h Length of down pipe

Installation with partially filled pipes

- Partially filled pipes with a gradient require a drain-type configuration.
- The installation of a cleaning valve is recommended.

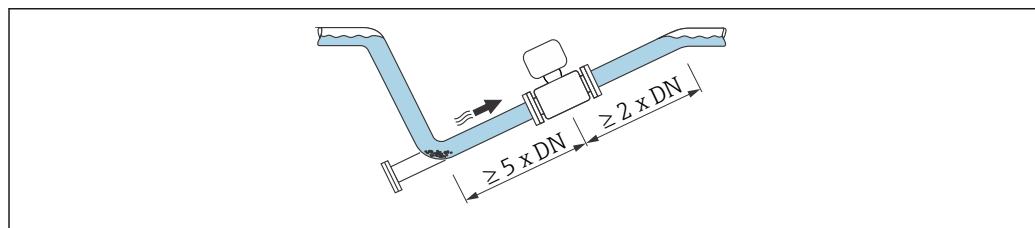

A0041088

i No inlet and outlet runs for devices with the order code for "Design": Option C, H, I, J or K.

Installation near pumps

NOTICE

Negative pressure in the measuring pipe can damage the liner!

- In order to maintain the system pressure, install the device in the flow direction downstream from the pump.
- Install pulsation dampers if reciprocating, diaphragm or peristaltic pumps are used.

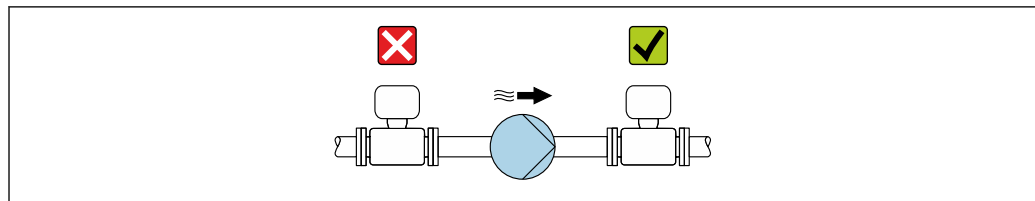

A0041083

- i** Information on the liner's resistance to partial vacuum → 51
- Information on the measuring system's resistance to vibration and shock → 47

Installation of very heavy devices

Support required for nominal diameters of DN \geq 350 mm (14 in).

NOTICE

Damage to the device!

If incorrect support is provided, the sensor housing could buckle and the internal magnetic coils could be damaged.

- Only provide supports at the pipe flanges.

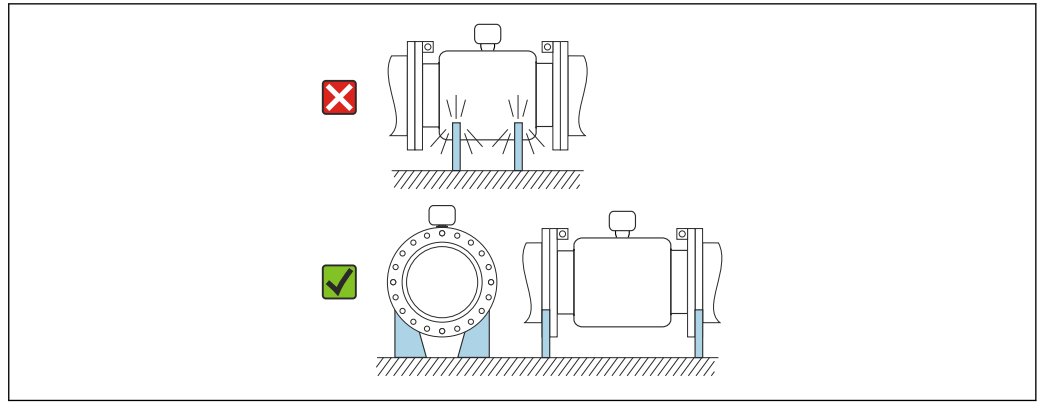

A0041087

Installation in event of pipe vibrations

A remote version is recommended in the event of strong pipe vibrations.



NOTICE

Pipe vibrations can damage the device!

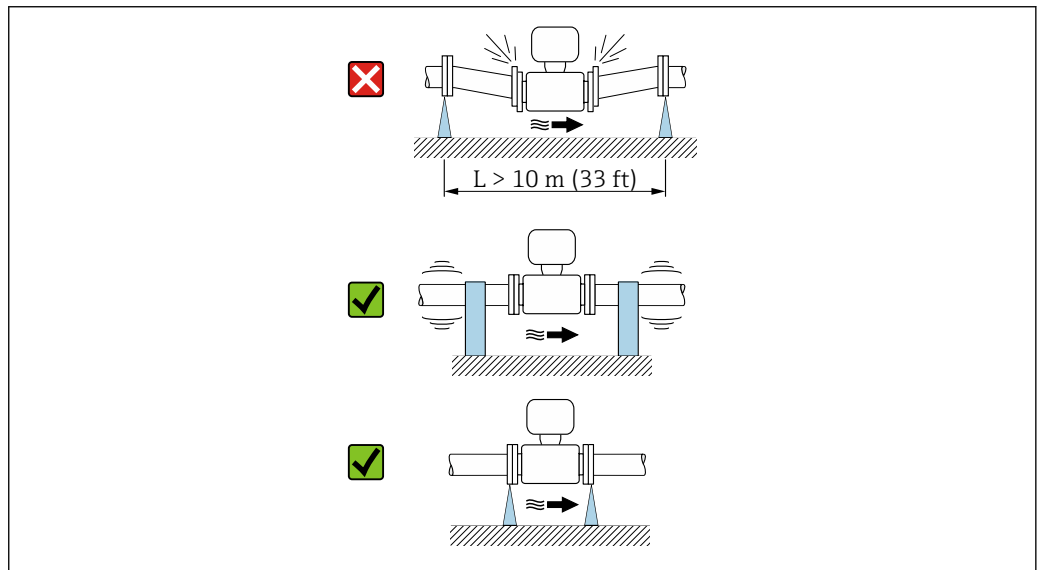
- ▶ Do not expose the device to strong vibrations.
- ▶ Support the pipe and fix it in place.
- ▶ Support the device and fix it in place.
- ▶ Mount the sensor and transmitter separately.





A0041092

 Information on the measuring system's resistance to vibration and shock →  47

Orientation

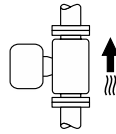
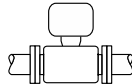
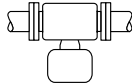
The direction of the arrow on the sensor nameplate helps you to install the sensor according to the flow direction (direction of medium flow through the piping).

Orientation		Recommendation
Vertical orientation	 A0015591	✓✓
Horizontal orientation, transmitter at top	 A0015589	✓✓ ¹⁾
Horizontal orientation, transmitter at bottom	 A0015590	✓✓ ^{2) 3)} ✗ ⁴⁾
Horizontal orientation, transmitter at side	 A0015592	✗

- 1) Applications with low process temperatures may decrease the ambient temperature. To maintain the minimum ambient temperature for the transmitter, this orientation is recommended.
- 2) Applications with high process temperatures may increase the ambient temperature. To maintain the maximum ambient temperature for the transmitter, this orientation is recommended.
- 3) To prevent the electronics module from overheating in the case of a sharp rise in temperature (e.g. CIP or SIP processes), install the device with the transmitter component pointing downwards.
- 4) With the empty pipe detection function switched on: empty pipe detection only works if the transmitter housing is pointing upwards.

Vertical

Optimum for self-emptying pipe systems and for use in conjunction with empty pipe detection.

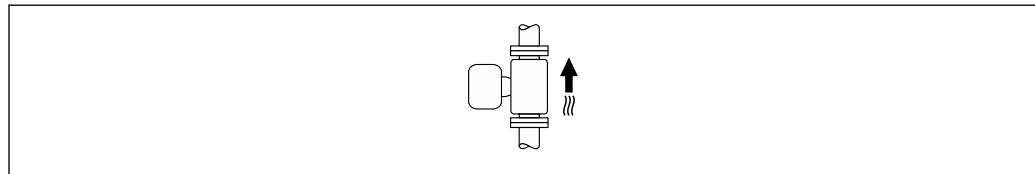

A0015591

Horizontal

- Ideally, the measuring electrode plane should be horizontal. This prevents brief insulation of the measuring electrodes by entrained air bubbles.
- Empty pipe detection only works if the transmitter housing is pointing upwards as otherwise there is no guarantee that the empty pipe detection function will actually respond to a partially filled or empty measuring tube.

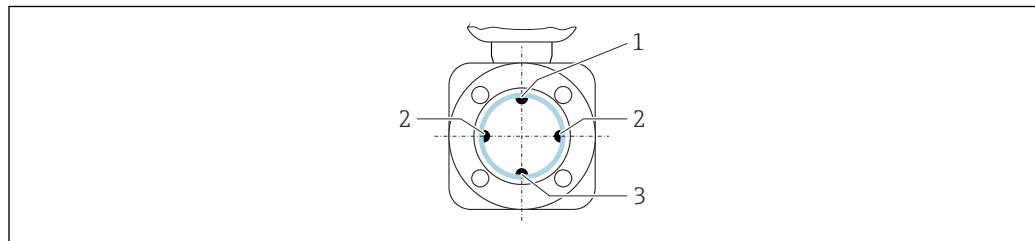

A0029344

- 1 EPD electrode for empty pipe detection
- 2 Measuring electrodes for signal detection
- 3 Reference electrode for potential equalization

Inlet and outlet runs

Installation with inlet and outlet runs

Installation requires inlet and outlet runs: devices with the order code for "Design", option D, E, F and G.

Installation with elbows, pumps or valves

To avoid a vacuum and to maintain the specified level of accuracy, install the device upstream from assemblies that produce turbulence (e.g. valves, T-sections) and downstream from pumps, wherever possible.

Maintain straight, unimpeded inlet and outlet runs.

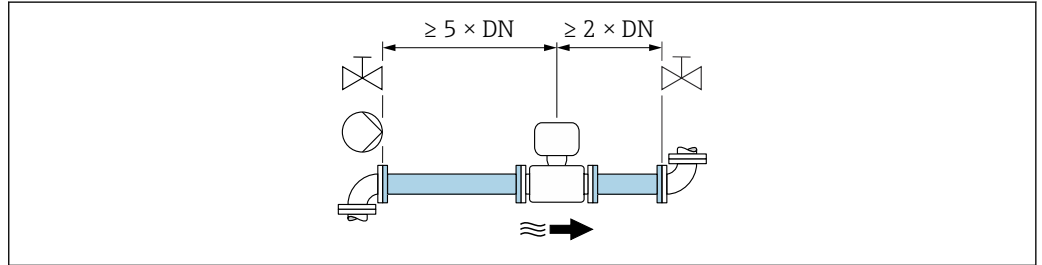

A0028997

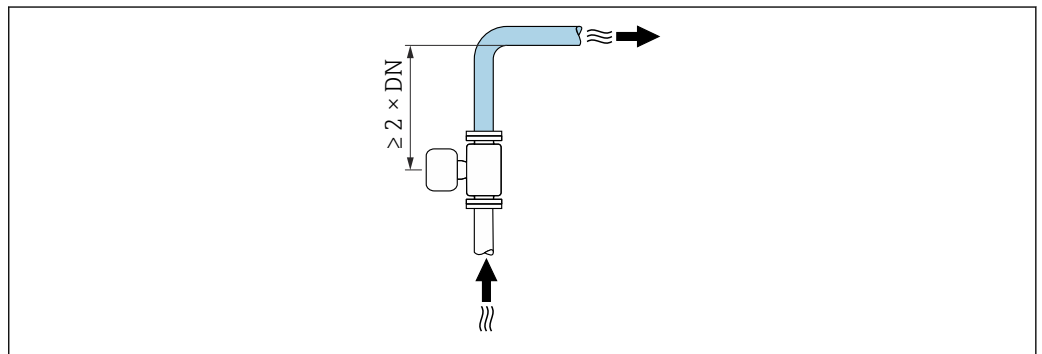

A0042132

Installation without inlet and outlet runs

Depending on the device design and installation location, the inlet and outlet runs can be reduced or omitted entirely.

i **Maximum measured error**

When the device is installed with the inlet and outlet runs described, a maximum measured error of $\pm 0.5\%$ of the reading $\pm 1 \text{ mm/s}$ (0.04 in/s) can be guaranteed.

Devices and possible order options

Order code for "Design"		
Option	Description	Design
C	Fixed flange, constricted measuring tube, 0 x DN inlet/outlet runs	Constricted measuring tube ¹⁾
H	Lap joint flange, 0 x DN inlet/outlet runs	Full Bore ²⁾
I	Fixed flange, 0 x DN inlet/outlet runs	
J	Fixed flange, short installed length, 0 x DN inlet/outlet runs	
K	Fixed flange, long installed length, 0 x DN inlet/outlet runs	

- 1) "Constricted measuring tube" stands for a reduction of the internal diameter of the measuring tube. The reduced internal diameter causes a higher flow velocity inside the measuring tube.
- 2) "Full Bore" stands for the full diameter of the measuring tube. There is no pressure loss with a full diameter.

Installation before or after bends

Installation without inlet and outlet runs is possible: devices with the order code for "Design", option C, H, I, J and K.

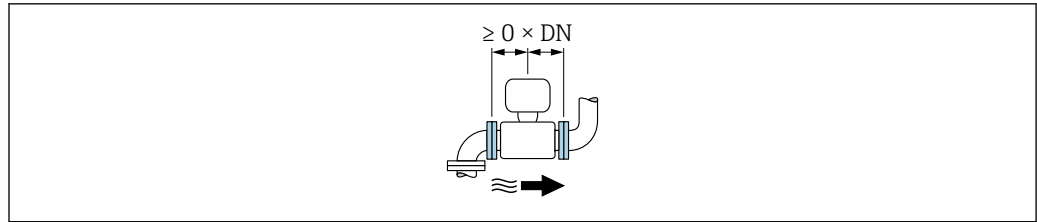

Installation downstream of pumps

Installation without inlet and outlet runs is possible: devices with the order code for "Design", option C, H and I.

i In the case of devices with the order code for "Design", option J and K, an inlet run of only $\geq 2 \times DN$ must be taken into consideration.

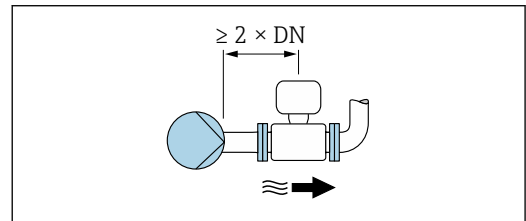

Installation upstream of valves

Installation without inlet and outlet runs is possible: devices with the order code for "Design", option C, H and I.

i In the case of devices with the order code for "Design", option J and K, an outlet run of only $\geq 1 \times DN$ must be taken into consideration.

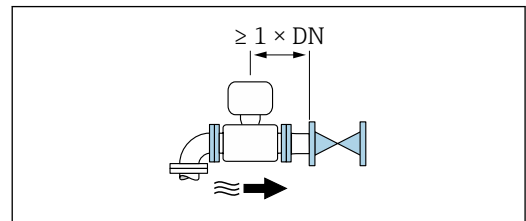

Installation downstream of valves

Installation without inlet and outlet runs is possible if the valve is 100% open during operation: devices with the order code for "Design", option C, H and I.

i In the case of devices with the order code for "Design", option J and K, an inlet run of only $\geq 2 \times DN$ must be taken into consideration if the valve is 100% open during operation.

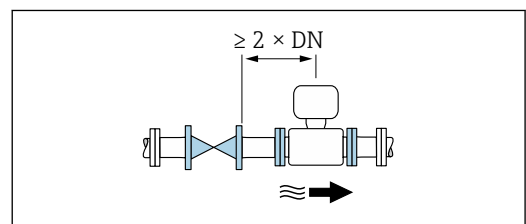

Adapters

Suitable adapters to DIN EN 545 (double-flange reducers) can be used to install the sensor in larger-diameter pipes. The resultant increase in the rate of flow improves measuring accuracy with very slow-moving fluids.

The nomogram shown here can be used to calculate the pressure loss caused by reducers and expanders:

- Calculate the ratio of the diameters d/D .
- From the nomogram read off the pressure loss as a function of flow velocity (downstream from the reduction) and the d/D ratio.

i The nomogram only applies to liquids with a viscosity similar to that of water.

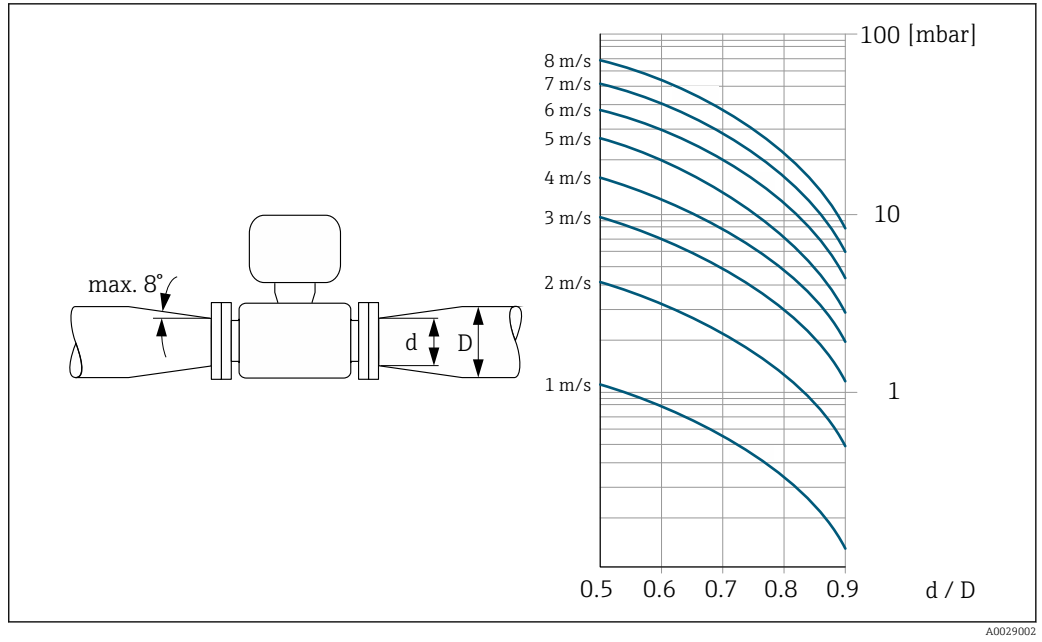

Length of connecting cable

To obtain correct measurement results, observe the permitted connecting cable length of L_{max} . This length is determined by the conductivity of the fluid. If measuring liquids in general: 5 $\mu\text{S}/\text{cm}$

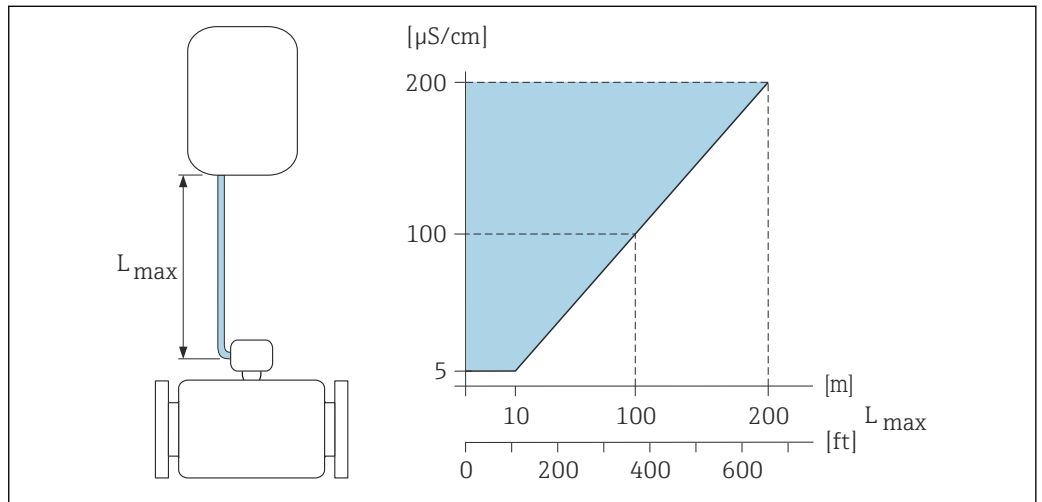

17 Permitted length of connecting cable

Colored area = permitted range
 L_{max} = length of connecting cable in [m] ([ft])
 $[\mu\text{S}/\text{cm}]$ = fluid conductivity

Special mounting instructions

Display guard

To ensure that the optional display guard can be easily opened, maintain the following minimum head clearance: 350 mm (13.8 in)

Immersion in water

- i** Only the remote version of the device with IP68 protection, Type 6P is suitable for underwater use: order code for "Sensor option", options CB, CC, CD, CE and CQ.
- Pay attention to regional installation instructions.

NOTICE

If the maximum water depth and operating duration is exceeded, this can damage the device!

- Observe the maximum water depth and operating duration.

Order code for "Sensor option", options CB, CC

- For the operation of the device under water
- Operating duration at a maximum depth of:
 - 3 m (10 ft): permanent use
 - 10 m (30 ft): maximum 48 hours

Order code for "Sensor option", option CQ "Temporarily water-proof "

- For the temporary operation of the device under non-corrosive water
- Operating duration at a maximum depth of:
 - 3 m (10 ft): maximum 168 hours

Order code for "Sensor option", options CD, CE

- For the operation of the device under water and in saline water
- Operating duration at a maximum depth of:
 - 3 m (10 ft): permanent use
 - 10 m (30 ft): maximum 48 hours

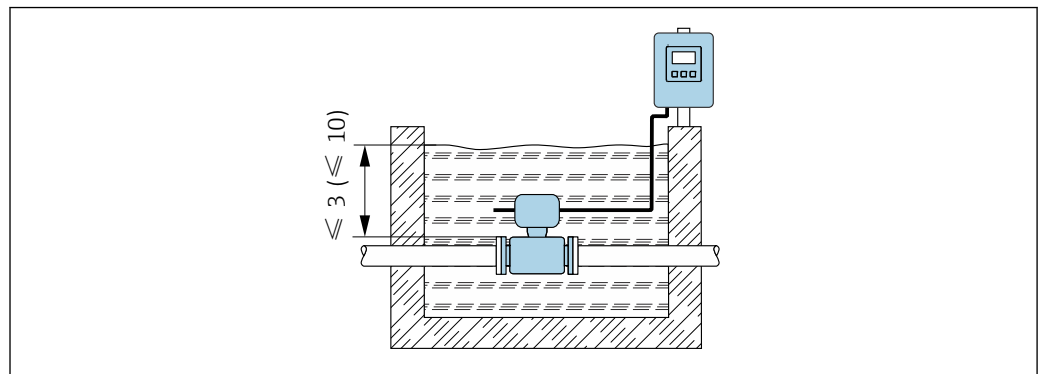

A0042412

Use in buried applications

- Only the remote version of the device with IP68 protection is suitable for use in buried applications: order code for "Sensor option", options CD and CE.
- Pay attention to regional installation instructions.

Order code for "Sensor option", options CD, CE

For the use of the device in buried applications.

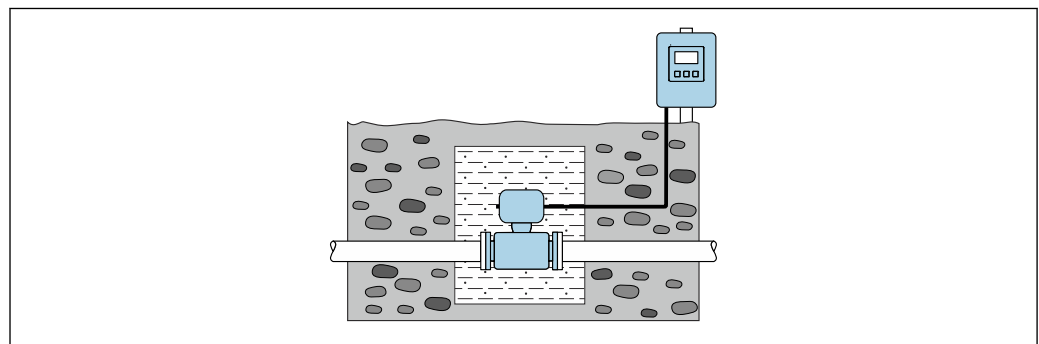

A0042646

Mounting the transmitter housing

Wall mounting

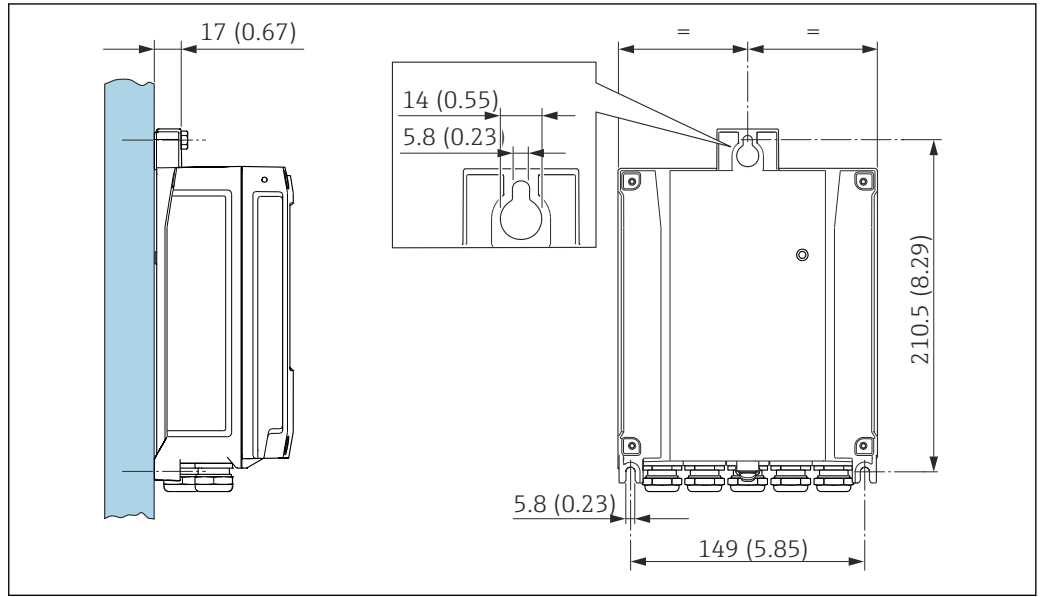

A0020523

18 Engineering unit mm (in)

Post mounting

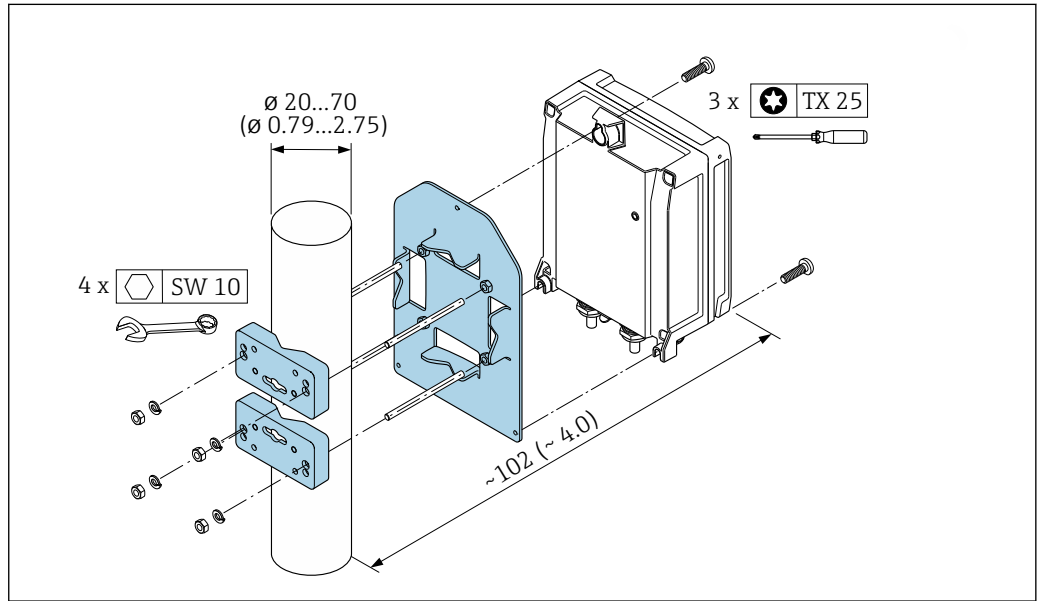

A0029051

19 Engineering unit mm (in)

Environment

Ambient temperature range

Transmitter	-40 to +60 °C (-40 to +140 °F)
Local display	-20 to +60 °C (-4 to +140 °F), the legibility of the local display may be impaired at temperatures outside the temperature range.

Sensor	<ul style="list-style-type: none"> ▪ Process connection material, carbon steel: -10 to +60 °C (+14 to +140 °F) ▪ Process connection material, stainless steel: -40 to +60 °C (-40 to +140 °F) <p>If both the ambient and the medium temperatures are high, mount the sensor separately from the transmitter.</p>
Liner	Do not exceed or fall below the permitted temperature range of the liner →  48.

If operating outdoors:

- Install the measuring device in a shady location.
- Avoid direct sunlight, particularly in warm climatic regions.
- Avoid direct exposure to weather conditions.
- If the compact version of the device is insulated at low temperatures, the insulation must also include the device neck.
- Protect the display against impact.
- Protect the display from abrasion, e.g. caused by sand in desert areas.



Display guard available as an accessory →  103.

Temperature tables



Observe the interdependencies between the permitted ambient and fluid temperatures when operating the device in hazardous areas.



For detailed information on the temperature tables, see the separate document entitled "Safety Instructions" (XA) for the device.

Storage temperature

The storage temperature corresponds to the operating temperature range of the transmitter and the sensor →  45.

- Protect the measuring device against direct sunlight during storage in order to avoid unacceptably high surface temperatures.
- Select a storage location where moisture cannot collect in the measuring device as fungus or bacteria infestation can damage the liner.
- If protection caps or protective covers are mounted these should never be removed before installing the measuring device.

Atmosphere

If a plastic transmitter housing is permanently exposed to certain steam and air mixtures, this can damage the housing.



In cases of doubt, please contact the Sales Center.

Degree of protection

Transmitter

- IP66/67, type 4X enclosure
- When housing is open: IP20, type 1 enclosure
- Display module: IP20, type 1 enclosure

Sensor

Compact and remote version

IP66/67, type 4X enclosure

Optionally available for compact and remote version:

Order code for "Sensor option", option CA, C3

- IP66/67, type 4X enclosure
- Fully welded, with protective coating as per EN ISO 12944 C5-M
- For the operation of the device in corrosive environments

Optionally available for remote version:

Order code for "Sensor option", option CB, CC

- IP68, type 6P enclosure
- Fully welded, with protective coating as per EN ISO 12944 C5-M/Im1 and EN 60529
- For the operation of the device under water
- Operating duration at a maximum depth of:
 - 3 m (10 ft): permanent use
 - 10 m (30 ft): maximum 48 hours

Order code for "Sensor option", option CQ

- IP68, type 6P, temporarily waterproof
- Sensor with aluminum half-shell housing
- For the temporary operation of the device under non-corrosive water
- Operating duration at a maximum depth of:
 - 3 m (10 ft): maximum 168 hours

Order code for "Sensor option", option CD, CE

- IP68, type 6P enclosure
- Fully welded, with protective coating as per EN ISO 12944 Im2/Im3 and EN 60529
- For the operation of the device in buried applications
- For the operation of the device under water and in saline water
- Operating duration at a maximum depth of:
 - 3 m (10 ft): permanent use
 - 10 m (30 ft): maximum 48 hours

Vibration- and shock-resistance

Sinusoidal vibration according to IEC 60068-2-6

Compact version; order code for "Housing", option A "Compact, aluminum, coated"

- 2 to 8.4 Hz, 3.5 mm peak
- 8.4 to 2 000 Hz, 1 g peak

Compact version; order code for "Housing", option M "Compact, polycarbonate"

- 2 to 8.4 Hz, 7.5 mm peak
- 8.4 to 2 000 Hz, 2 g peak

Remote version; order code for "Housing", option N "Remote, polycarbonate" and option P "Remote, aluminum, coated"

- 2 to 8.4 Hz, 7.5 mm peak
- 8.4 to 2 000 Hz, 2 g peak

Vibration broad-band random, according to IEC 60068-2-64

Compact version; order code for "Housing", option A "Compact, aluminum, coated"

- 10 to 200 Hz, 0.003 g²/Hz
- 200 to 2 000 Hz, 0.001 g²/Hz
- Total: 1.54 g rms

Compact version; order code for "Housing", option M "Compact, polycarbonate"

- 10 to 200 Hz, 0.01 g²/Hz
- 200 to 2 000 Hz, 0.003 g²/Hz
- Total: 2.70 g rms

Remote version; order code for "Housing", option N "Remote, polycarbonate" and option P "Remote, aluminum, coated"

- 10 to 200 Hz, 0.01 g²/Hz
- 200 to 2 000 Hz, 0.003 g²/Hz
- Total: 2.70 g rms

Shock half-sine, according to IEC 60068-2-27

- Compact version; order code for "Housing", option A "Compact, aluminum, coated"
6 ms 30 g
- Compact version; order code for "Housing", option M "Compact, polycarbonate"
6 ms 50 g
- Remote version; order code for "Housing", option N "Remote, polycarbonate" and option P "Remote, aluminum, coated"
6 ms 50 g

Rough handling shocks according to IEC 60068-2-31

Mechanical load

- Protect the transmitter housing against mechanical effects, such as shock or impact; the use of the remote version is sometimes preferable.
- Never use the transmitter housing as a ladder or climbing aid.

Electromagnetic compatibility (EMC)

- As per IEC/EN 61326 and NAMUR Recommendation 21 (NE 21)
- Complies with emission limits for industry as per EN 55011 (Class A)
- Device version with PROFIBUS DP: Complies with emission limits for industry as per EN 50170 Volume 2, IEC 61784

 The following applies for PROFIBUS DP: If baud rates > 1.5 MBaud, an EMC cable entry must be used and the cable shield must continue as far as the terminal wherever possible.

 Details are provided in the Declaration of Conformity.

Process

Medium temperature range

- 0 to +80 °C (+32 to +176 °F) for hard rubber, DN 50 to 3000 (2 to 120")
- -20 to +50 °C (-4 to +122 °F) for polyurethane, DN 25 to 1200 (1 to 48")
- -20 to +90 °C (-4 to +194 °F) for PTFE, DN 25 to 300 (1 to 12")

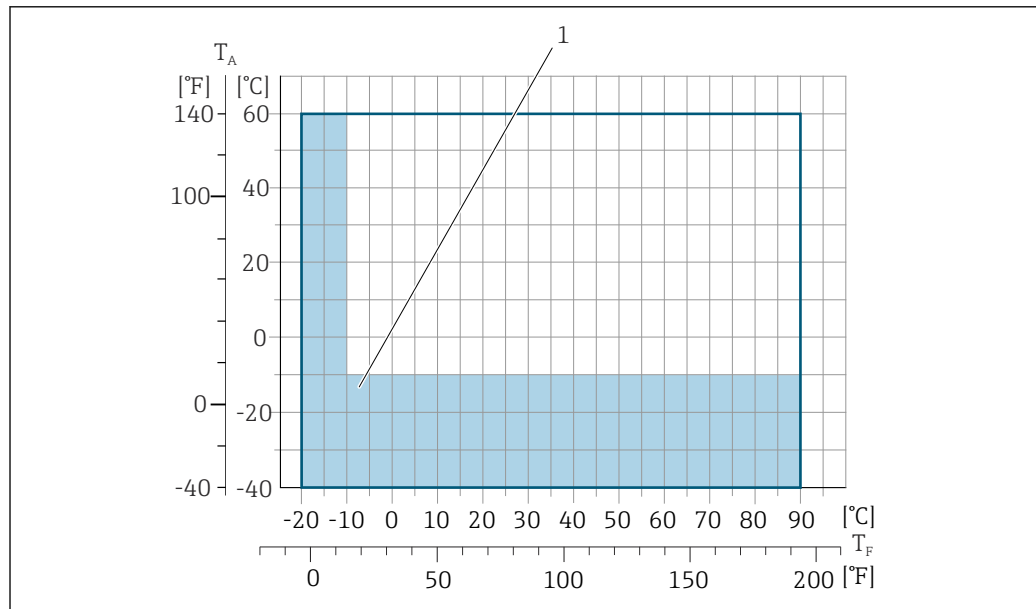

T_A Ambient temperature



T_F Medium temperature

1 Colored area: The ambient temperature range of -10 to -40 °C (+14 to -40 °F) and the medium temperature range of -10 to -20 °C (+14 to -4 °F) only apply for stainless flanges

 The permitted fluid temperature in custody transfer is 0 to +50 °C (+32 to +122 °F).

Conductivity

≥5 μS/cm for liquids in general.

- Note that in the case of the remote version, the requisite minimum conductivity additionally depends on the length of the connecting cable →  43.
- Maximum measured error for electrical conductivity →  35.

Pressure/temperature ratings

The following pressure/temperature diagrams apply to all pressure-bearing parts of the device and not just the process connection. The diagrams show the maximum permissible medium pressure depending on the specific medium temperature.

Process connection: fixed flange according to EN 1092-1 (DIN 2501)

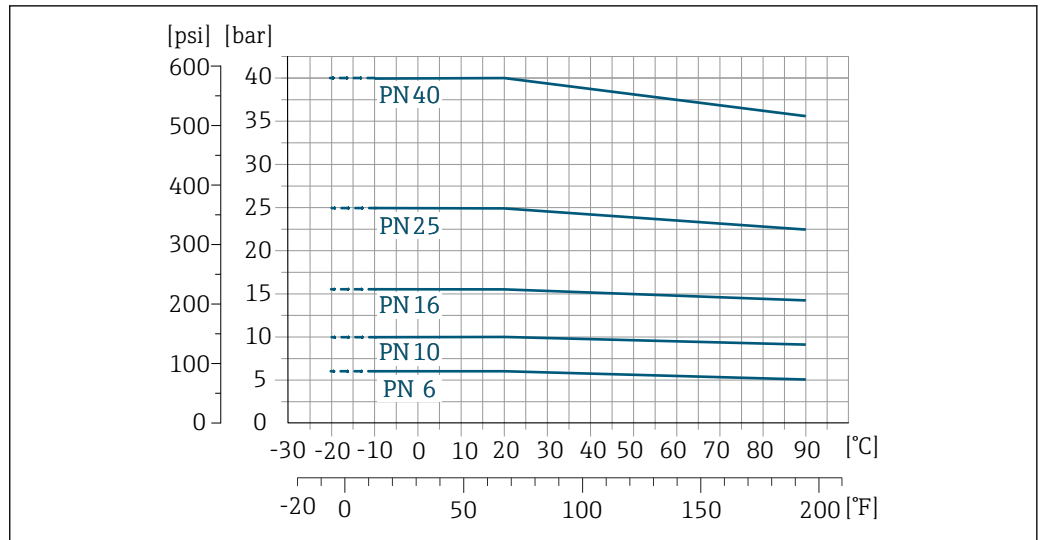

20 Process connection material: stainless steel (-20 °C (-4 °F)); carbon steel (-10 °C (14 °F))

Process connection: fixed flange according to ASME B16.5

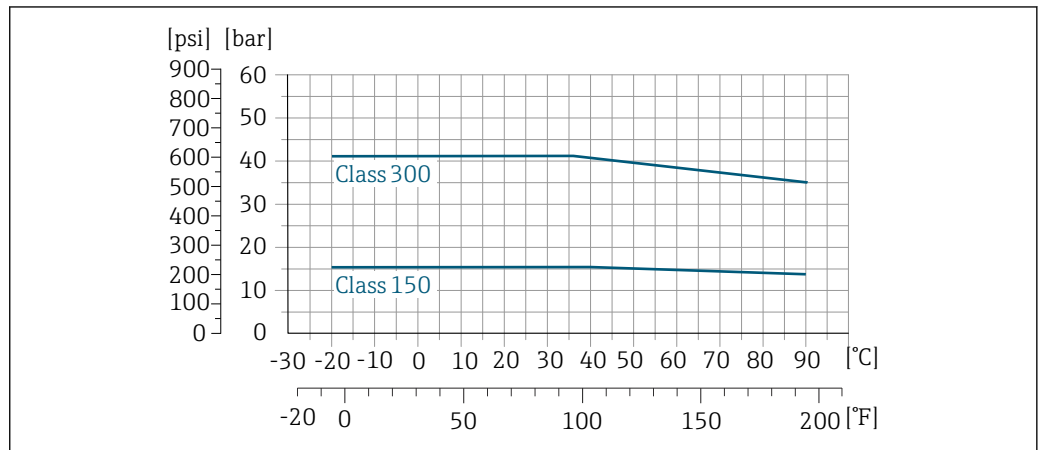

21 Process connection material: stainless steel

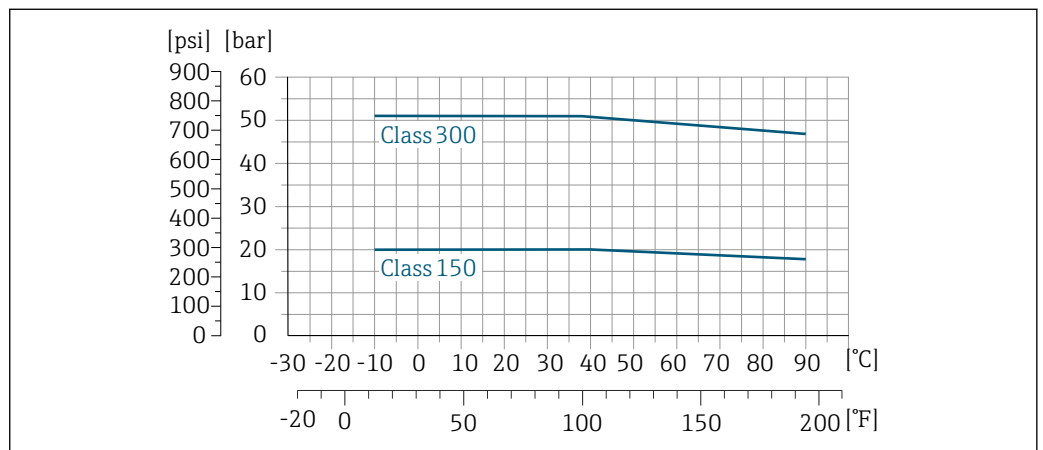

22 Process connection material: carbon steel

Process connection: fixed flange according to JIS B2220

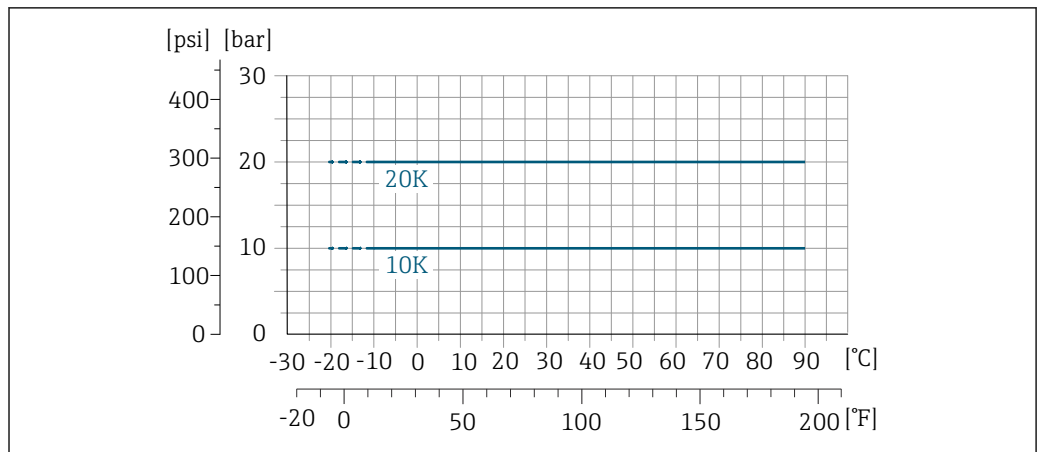

A0038124-EN

23 Process connection material: stainless steel (-20 °C (-4 °F)); carbon steel (-10 °C (14 °F))

Process connection: fixed flange according to AWWA C207

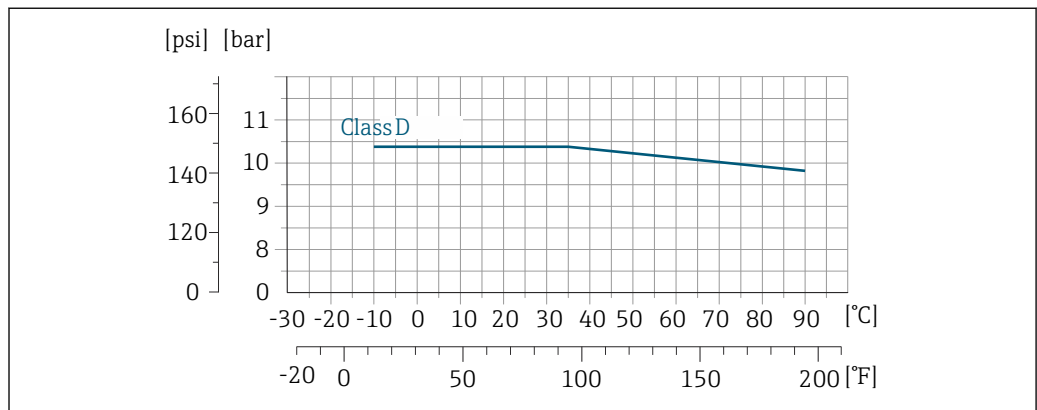

A0038126-EN

24 Process connection material: carbon steel

Process connection: fixed flange according to AS 2129

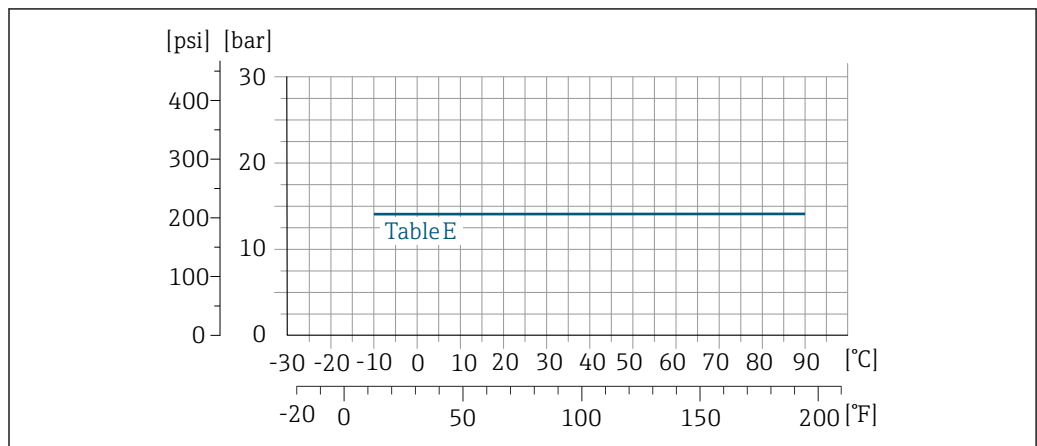

A0038127-EN

25 Process connection material: carbon steel

Process connection: fixed flange according to AS 4087

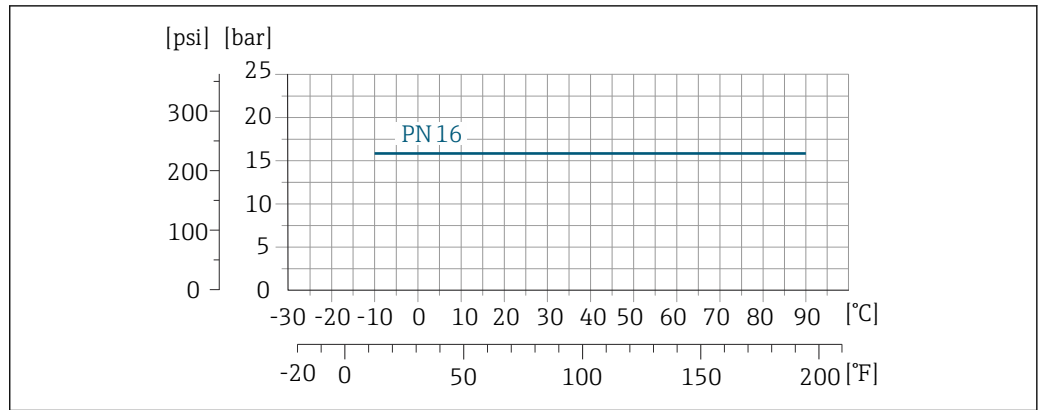

26 Process connection material: carbon steel

Process connection: lap joint flange/lap joint flange, stamped plate according to EN 1092-1 (DIN 2501) and ASME B16.5; DN 25 to 300 (1 to 12")

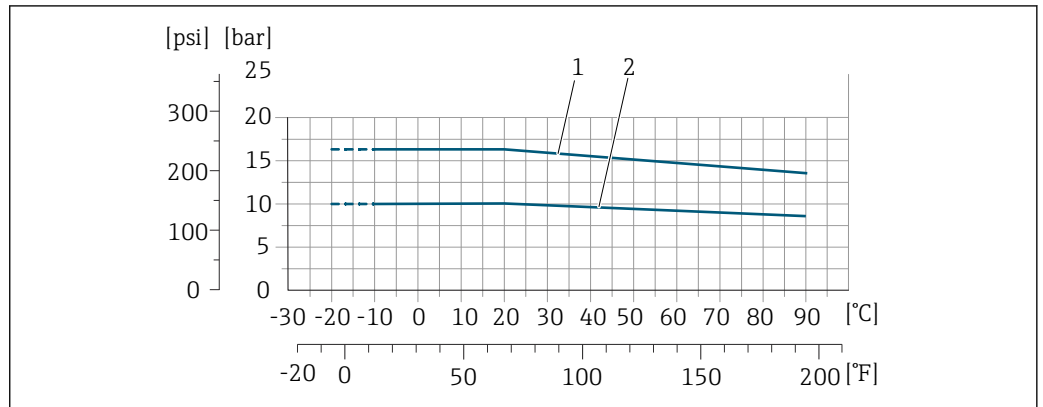

27 Process connection material: stainless steel (-20 °C (-4 °F)); carbon steel (-10 °C (14 °F))

- 1 Lap joint flange PN16/ Class150
- 2 Lap joint flange, stamped plate PN10, lap joint flange PN10

Pressure tightness

Liner: hard rubber

Nominal diameter		Limit values for absolute pressure in [mbar] ([psi]) for medium temperatures:		
[mm]	[in]	+25 °C (+77 °F)	+50 °C (+122 °F)	+80 °C (+176 °F)
50 ... 3000	2 ... 120	0 (0)	0 (0)	0 (0)

Liner: polyurethane

Nominal diameter		Limit values for absolute pressure in [mbar] ([psi]) for medium temperatures:	
[mm]	[in]	+25 °C (+77 °F)	+50 °C (+122 °F)
25 ... 1200	1 ... 48	0 (0)	0 (0)

Liner: PTFE

Nominal diameter		Limit values for absolute pressure in [mbar] ([psi]) for medium temperatures:	
[mm]	[in]	+25 °C (+77 °F)	+90 °C (+194 °F)
25	1	0 (0)	0 (0)
40	2	0 (0)	0 (0)

Nominal diameter		Limit values for absolute pressure in [mbar] ([psi]) for medium temperatures:	
[mm]	[in]	+25 °C (+77 °F)	+90 °C (+194 °F)
50	2	0 (0)	0 (0)
65	2 ½	0 (0)	40 (0.58)
80	3	0 (0)	40 (0.58)
100	4	0 (0)	135 (2.0)
125	5	135 (2.0)	240 (3.5)
150	6	135 (2.0)	240 (3.5)
200	8	200 (2.9)	290 (4.2)
250	10	330 (4.8)	400 (5.8)
300	12	400 (5.8)	500 (7.3)

Flow limit

The diameter of the pipe and the flow rate determine the nominal diameter of the sensor. The optimum velocity of flow is between 2 to 3 m/s (6.56 to 9.84 ft/s). Also match the velocity of flow (v) to the physical properties of the medium:

- v < 2 m/s (6.56 ft/s): for abrasive media (e.g. potter's clay, lime milk, ore slurry)
- v > 2 m/s (6.56 ft/s): for media producing buildup (e.g. wastewater sludge)

i A necessary increase in the flow velocity can be achieved by reducing the sensor nominal diameter.

i For an overview of the full scale values for the measuring range, see the "Measuring range" section → 8

i For custody transfer, the applicable approval determines the permitted measuring range.

Pressure loss

- No pressure loss occurs if the sensor is installed in a pipe with the same nominal diameter.
- Pressure losses for configurations incorporating adapters according to DIN EN 545 → 42

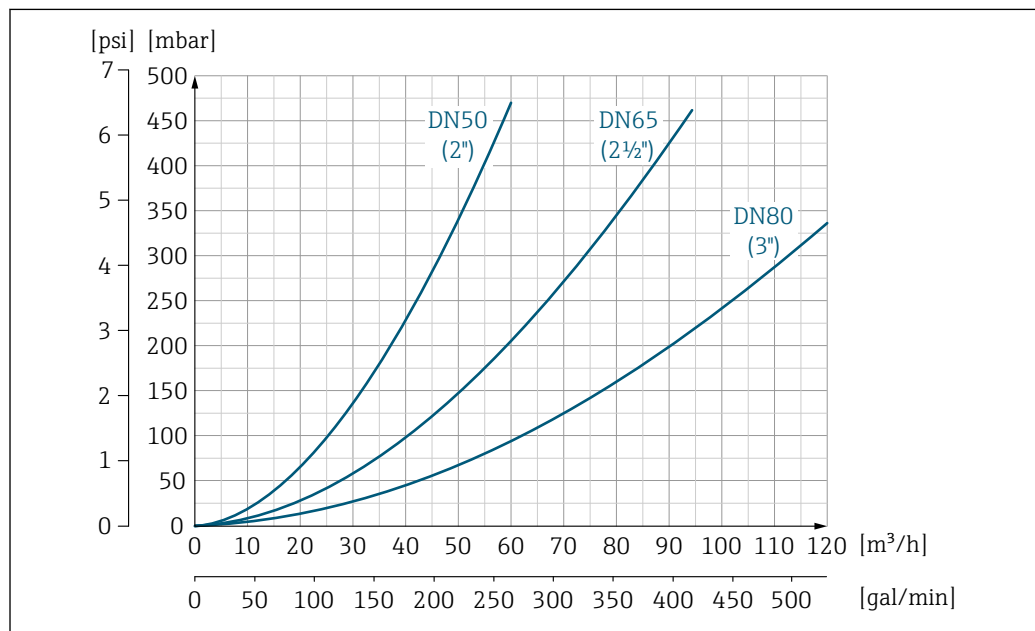

28 Pressure loss DN 50 to 80 (2 to 3") for order code for "Design", option C "Fixed flange, constricted measuring tube", 0 x DN inlet/outlet runs"

A0032667-EN

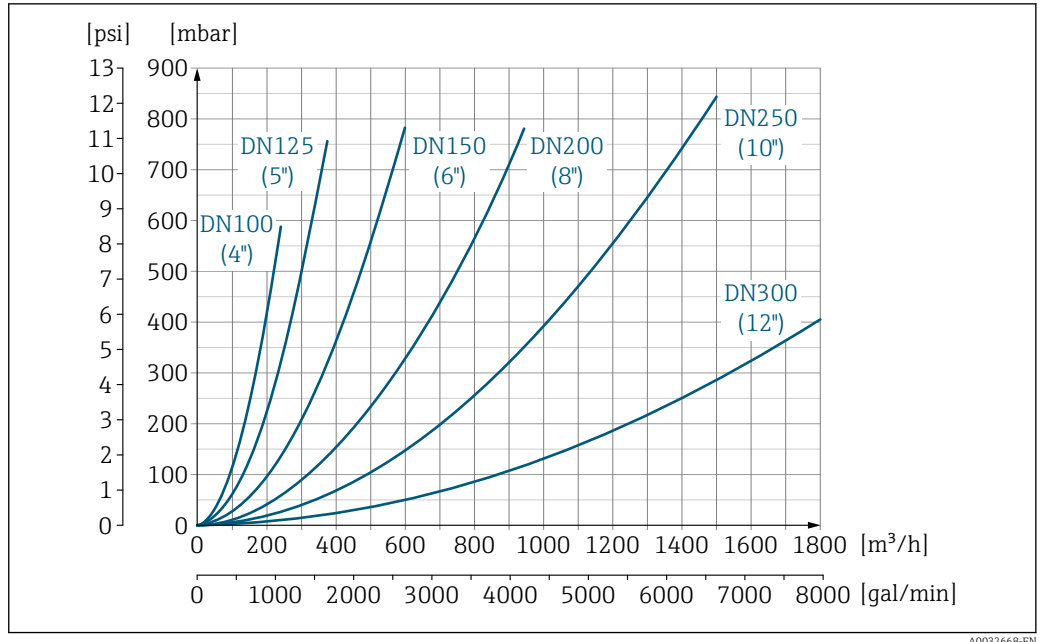

29 Pressure loss DN 100 to 300 (4 to 12") for order code for "Design", option C "Fixed flange, constricted measuring tube", 0 x DN inlet/outlet runs"

System pressure

Installation near pumps → 38

Vibrations

Installation in event of pipe vibrations → 39

Custody transfer mode

The measuring device is optionally tested in accordance with OIML R49 and has an EU type-examination certificate according to Measuring Instruments Directive 2014/32/EU for service subject to legal metrological control ("custody transfer") for cold water (Annex III).

The permitted medium temperature in these applications is 0 to +50 °C (+32 to +122 °F).

The device is used with a legally controlled totalizer on the local display and optionally with legally controlled outputs.

Measuring devices subject to legal metrological control totalize in both directions, i.e. all the outputs consider flow components in the positive (forward) and negative (reverse) flow direction.

Generally a measuring device subject to legal metrological control is secured against tampering by seals on the transmitter or sensor. These seals may normally only be opened by a representative of the competent authority for legal metrology controls.

After putting the device into circulation or after sealing the device, operation is only possible to a limited extent.

Detailed ordering information is available from your local Endress+Hauser sales center for national approvals (outside Europe) as cold water meters based on OIML R49.

Mechanical construction

Dimensions in SI units

Compact version

Order code for "Housing", option A "Compact, aluminum, coated" or option M "Compact, polycarbonate"

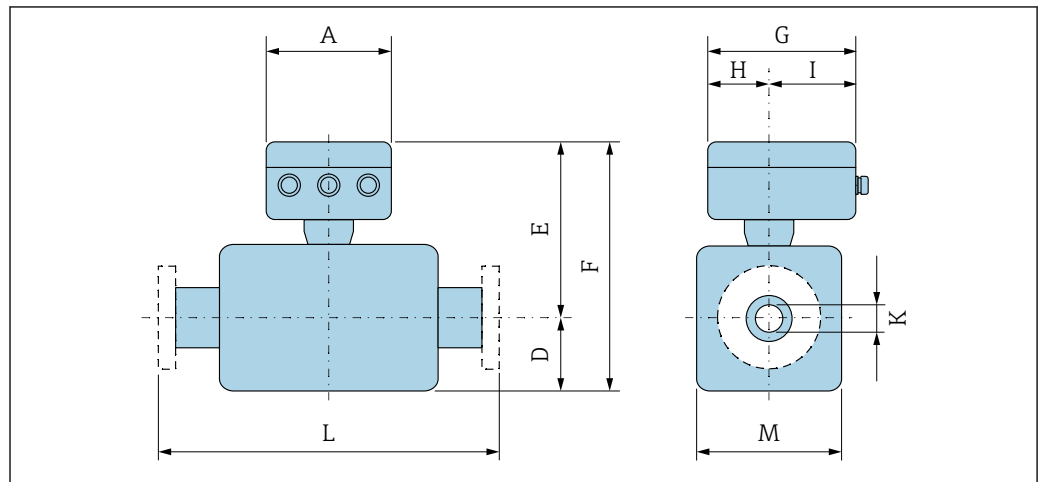

A0033790

A [mm]	G ¹⁾ [mm]	H [mm]	I ¹⁾ [mm]
167	193	90	103

1) Depending on the cable gland used: values up to + 30 mm

DN 25 to 300 mm (1 to 12 in): Sensor with aluminum half-shell housing

DN		Order code for "Design"								K	L
		Options D, E, H, I				Option C					
[mm]	[in]	D ¹⁾ [mm]	E ¹⁾ [mm]	F ¹⁾ [mm]	M ¹⁾ [mm]	D ¹⁾ [mm]	E ¹⁾ [mm]	F ¹⁾ [mm]	M ¹⁾ [mm]	[mm]	[mm]
25	1	84	201	285	120	-	-	-	-	²⁾	200
32	-	84	201	285	120	-	-	-	-	²⁾	200
40	1 ½	84	201	285	120	-	-	-	-	²⁾	200
50	2	84	201	285	120	84	201	285	120	²⁾	200
65	-	109	226	335	180	84	201	285	120	²⁾	200
80	3	109	226	335	180	84	201	285	120	²⁾	200
100	4	109	226	335	180	109	226	335	180	²⁾	250
125	-	150	266	416	260	109	226	335	180	²⁾	250
150	6	150	266	416	260	109	226	335	180	²⁾	300
200	8	180	291	471	324	150	266	416	260	²⁾	350
250	10	205	316	521	400	150	266	416	260	²⁾	450
300	12	230	341	571	460	180	291	471	324	²⁾	500

- 1) The dimensions are reference values. They may vary depending on the pressure rating, design and order option.
- 2) Depends on the liner → 90

DN 350 to 400 mm (14 to 16 in)

DN		Order code for "Design"				K	L
		Options E, I					
[mm]	[in]	D ¹⁾ [mm]	E ¹⁾ [mm]	F ¹⁾ [mm]	M ¹⁾ [mm]	[mm]	[mm]
350	14	282	379	679	564	²⁾	550
375	15	308	423	731	616	²⁾	600
400	16	308	423	731	616	²⁾	600

- 1) The dimensions are reference values. They may vary depending on the pressure rating, design and order option.
- 2) Depends on the liner → 90

DN 450 to 900 mm (18 to 36 in)

DN		Order code for "Design"								K	L	
		Options F, J				Options G, K						
[mm]	[in]	D ¹⁾ [mm]	E ¹⁾ [mm]	F ¹⁾ [mm]	M ¹⁾ [mm]	D ¹⁾ [mm]	E ¹⁾ [mm]	F ¹⁾ [mm]	M ¹⁾ [mm]	[mm]	[mm]	[mm]
450	18	290	405	695	580	333	448	781	666	²⁾	600 ³⁾	650 ⁴⁾
500	20	315	430	745	630	359	474	833	717	²⁾	600 ³⁾	650 ⁴⁾
600	24	365	480	845	730	411	526	937	821	²⁾	600 ³⁾	780 ⁴⁾
700	28	426	541	967	851	512	627	1139	1024	²⁾	700 ³⁾	910 ⁴⁾
750	30	463	578	1041	926	512	627	1139	1024	²⁾	750 ³⁾	975 ⁴⁾

DN		Order code for "Design"								K	L	
		Options F, J				Options G, K						
		D ¹⁾	E ¹⁾	F ¹⁾	M ¹⁾	D ¹⁾	E ¹⁾	F ¹⁾	M ¹⁾			
[mm]	[in]	[mm]	[mm]	[mm]	[mm]	[mm]	[mm]	[mm]	[mm]	[mm]	[mm]	
800	32	482	597	1079	964	534	649	1183	1065	²⁾	800 ³⁾	1040 ⁴⁾
900	36	532	647	1179	1064	610	725	1335	1218	²⁾	900 ³⁾	1170 ⁴⁾

- 1) The dimensions are reference values. They may vary depending on the pressure rating, design and order option.
- 2) Depends on the liner → 90
- 3) Order code for "Design", option F "Fixed flange, short installed length" and option J "Fixed flange, short installed length, 0 x DN inlet/outlet runs"
- 4) Order code for "Design", option G "Fixed flange, long installed length" and option K "Fixed flange, long installed length 0 x DN inlet/outlet runs"

DN 1000 to 2000 mm (40 to 78 in)

DN		Order code for "Design"					K	L	
		Options F, G, J, K							
		D ¹⁾	E ¹⁾	F ¹⁾	M ¹⁾				
[mm]	[in]	[mm]	[mm]	[mm]	[mm]	[mm]	[mm]	[mm]	
1000	40	582	697	1279	1164	²⁾	1000 ³⁾	1300 ⁴⁾	
-	42	618	733	1351	1236	²⁾	1050 ³⁾	1365 ⁴⁾	
1200	48	696	811	1507	1392	²⁾	1200 ³⁾	1560 ⁴⁾	
-	54	809	924	1733	1617	²⁾	1350 ³⁾	1755 ⁴⁾	
1400	-	809	924	1733	1617	²⁾	1400 ³⁾	1820 ⁴⁾	
-	60	909	1024	1933	1817	²⁾	1500 ³⁾	1950 ⁴⁾	
1600	-	909	1024	1933	1817	²⁾	1600 ³⁾	2080 ⁴⁾	
-	66	960	1075	2035	1919	²⁾	1650 ³⁾	2145 ⁴⁾	
1800	72	1016	1131	2147	2032	²⁾	1800 ³⁾	2340 ⁴⁾	
-	78	1127	1242	2369	2254	²⁾	2000 ³⁾	2600 ⁴⁾	
2000	-	1127	1242	2369	2254	²⁾	2000 ³⁾	2600 ⁴⁾	

- 1) The dimensions are reference values. They may vary depending on the pressure rating, design and order option.
- 2) Depends on the liner → 90
- 3) Order code for "Design", option F "Fixed flange, short installed length" and option J "Fixed flange, short installed length, 0 x DN inlet/outlet runs"
- 4) Order code for "Design", option G "Fixed flange, long installed length" and option K "Fixed flange, long installed length 0 x DN inlet/outlet runs"

DN 2200 to 3000 mm (84 to 120 in)

DN		Order code for "Design"				K	L
		Option F, J					
		D ¹⁾	E ¹⁾	F ¹⁾	M ¹⁾		
[mm]	[in]	[mm]	[mm]	[mm]	[mm]	[mm]	[mm]
-	84	1227	1342	2569	2454	²⁾	2200
2200	-	1227	1342	2569	2454	²⁾	2200
-	90	1332	1447	2779	2664	²⁾	2400
2400	-	1332	1447	2783	2664	²⁾	2400
-	96	1431	1546	2977	2861	²⁾	2450

DN		Order code for "Design"				K	L
		Option F, J					
[mm]	[in]	D ¹⁾ [mm]	E ¹⁾ [mm]	F ¹⁾ [mm]	M ¹⁾ [mm]	[mm]	[mm]
-	102	1516	1631	3147	3032	²⁾	2600
2600	-	1442	1557	2999	2883	²⁾	2600
-	108	1602	1718	3320	3204	²⁾	2750
2800	-	1547	1662	3209	3093	²⁾	2800
-	114	1688	1803	3491	3375	²⁾	2900
3000	-	1647	1762	3409	3293	²⁾	3000
-	120	1774	1889	3663	3547	²⁾	3050

- 1) The dimensions are reference values. They may vary depending on the pressure rating, design and order option.
- 2) Depends on the liner → 90

Remote version

Transmitter remote version

Order code for "Housing", option N "Remote, polycarbonate" or option P "Remote, aluminum coated"

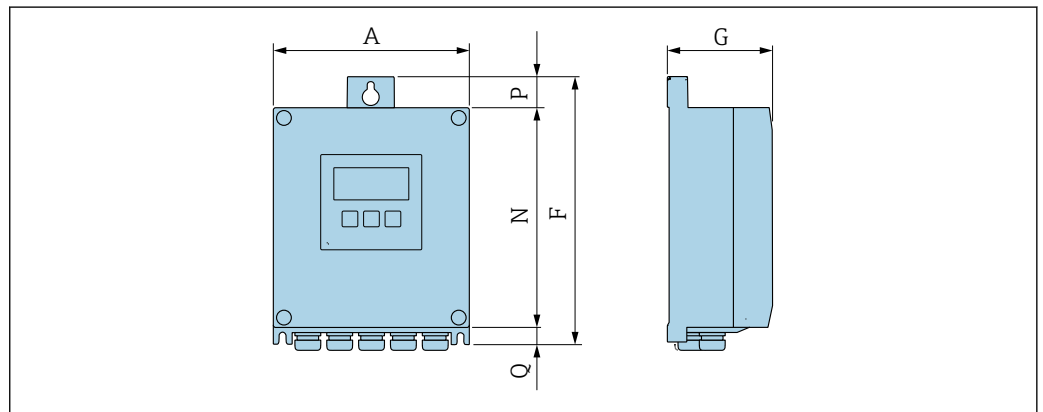

A0033789

Order code for "Transmitter housing", option P "Remote, aluminum, coated"

A [mm]	F [mm]	G [mm]	N [mm]	P [mm]	Q [mm]
167	232	80	187	24	21

Order code for "Transmitter housing", option N "Remote, polycarbonate"

A [mm]	F [mm]	G [mm]	N [mm]	P [mm]	Q [mm]
177	234	90	197	17	22

Sensor connection housing

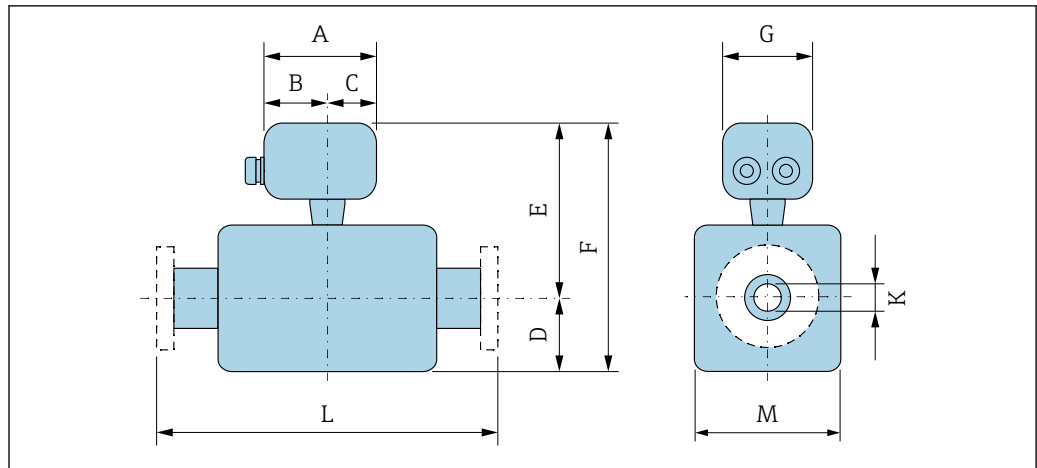

Aluminum, coated

A [mm]	B [mm]	C [mm]	G [mm]
148	94	54	136

Polycarbonate (only in conjunction with order code for "Sensor option", options CA...CE)

A [mm]	B [mm]	C [mm]	G [mm]
113	62	51	112

DN 25 to 300 mm (1 to 12 in): Sensor with aluminum half-shell housing

DN		Order code for "Design"								K	L
[mm]	[in]	Options D, E, H, I				Option C					
		D ¹⁾ [mm]	E ¹⁾ [mm]	F ¹⁾ [mm]	M ¹⁾ [mm]	D ¹⁾ [mm]	E ¹⁾ [mm]	F ¹⁾ [mm]	M ¹⁾ [mm]		
25	1	84	200	284	120	-	-	-	-	2)	200
32	-	84	200	284	120	-	-	-	-	2)	200
40	1 ½	84	200	284	120	-	-	-	-	2)	200
50	2	84	200	284	120	84	200	284	120	2)	200
65	-	109	225	334	180	84	200	284	120	2)	200
80	3	109	225	334	180	84	200	284	120	2)	200
100	4	109	225	334	180	109	225	334	180	2)	250
125	-	150	265	415	260	109	225	334	180	2)	250
150	6	150	265	415	260	109	225	334	180	2)	300
200	8	180	290	470	324	150	265	415	260	2)	350
250	10	205	315	520	400	150	265	415	260	2)	450
300	12	230	340	570	460	180	290	470	324	2)	500

- 1) The dimensions are reference values. They may vary depending on the pressure rating, design and order option.
- 2) Depends on the liner → 90

DN 25 to 300 mm (1 to 12 in): Sensor with fully welded carbon steel housing

DN		Order code for "Design"								K	L
		Option E				Option C					
[mm]	[in]	D ¹⁾ [mm]	E ¹⁾ [mm]	F ¹⁾ [mm]	M ¹⁾ [mm]	D ¹⁾ [mm]	E ¹⁾ [mm]	F ¹⁾ [mm]	M ¹⁾ [mm]	[mm]	[mm]
25	1	70	200	270	140	-	-	-	-	²⁾	200
32	-	70	200	270	140	-	-	-	-	²⁾	200
40	1 ½	70	200	270	140	-	-	-	-	²⁾	200
50	2	70	200	270	140	70	200	270	140	²⁾	200
65	-	82	225	307	165	70	200	270	140	²⁾	200
80	3	87	225	312	175	70	200	270	140	²⁾	200
100	4	100	225	325	200	82	225	307	165	²⁾	250
125	-	113	265	378	226	87	225	312	175	²⁾	250
150	6	134	265	399	269	100	225	325	200	²⁾	300
200	8	160	290	450	320	113	265	378	226	²⁾	350
250	10	193	315	508	387	134	265	399	269	²⁾	450
300	12	218	340	558	437	160	290	450	320	²⁾	500

- 1) The dimensions are reference values. They may vary depending on the pressure rating, design and order option.
 2) Depends on the liner → 90

DN 350 to 400 mm (14 to 16 in)

DN		Order code for "Design"				K	L
		Options E, I					
[mm]	[in]	D ¹⁾ [mm]	E ¹⁾ [mm]	F ¹⁾ [mm]	M ¹⁾ [mm]	[mm]	[mm]
350	14	282	379	679	564	²⁾	550
375	15	308	423	731	616	²⁾	550
400	16	308	423	731	616	²⁾	600

- 1) The dimensions are reference values. They may vary depending on the pressure rating, design and order option.
 2) Depends on the liner → 90

DN 450 to 900 mm (18 to 36 in)

DN		Order code for "Design"								K	L	
		Options F, J				Options G, K						
[mm]	[in]	D ¹⁾ [mm]	E ¹⁾ [mm]	F ¹⁾ [mm]	M ¹⁾ [mm]	D ¹⁾ [mm]	E ¹⁾ [mm]	F ¹⁾ [mm]	M ¹⁾ [mm]	[mm]	[mm]	[mm]
450	18	290	405	695	580	333	448	781	666	²⁾	600 ³⁾	650 ⁴⁾
500	20	315	430	745	630	359	474	833	717	²⁾	600 ³⁾	650 ⁴⁾
600	24	365	480	845	730	411	526	937	821	²⁾	600 ³⁾	780 ⁴⁾
700	28	426	541	967	851	512	627	1139	1024	²⁾	700 ³⁾	910 ⁴⁾
750	30	463	578	1041	926	512	627	1139	1024	²⁾	750 ³⁾	975 ⁴⁾

DN		Order code for "Design"								K	L	
		Options F, J				Options G, K						
		D ¹⁾	E ¹⁾	F ¹⁾	M ¹⁾	D ¹⁾	E ¹⁾	F ¹⁾	M ¹⁾			
[mm]	[in]	[mm]	[mm]	[mm]	[mm]	[mm]	[mm]	[mm]	[mm]	[mm]	[mm]	
800	32	482	597	1079	964	534	649	1183	1065	²⁾	800 ³⁾	1040 ⁴⁾
900	36	532	647	1179	1064	610	725	1335	1218	²⁾	900 ³⁾	1170 ⁴⁾

- 1) The dimensions are reference values. They may vary depending on the pressure rating, design and order option.
- 2) Depends on the liner → 90
- 3) Order code for "Design", option F "Fixed flange, short installed length" and option J "Fixed flange, short installed length, 0 x DN inlet/outlet runs"
- 4) Order code for "Design", option G "Fixed flange, long installed length" and option K "Fixed flange, long installed length 0 x DN inlet/outlet runs"

DN 1000 to 2000 mm (40 to 78 in)

DN		Order code for "Design"				K	L	
		Options F, G, J, K						
		D ¹⁾	E ¹⁾	F ¹⁾	M ¹⁾			
[mm]	[in]	[mm]	[mm]	[mm]	[mm]	[mm]	[mm]	
1000	40	582	697	1279	1164	²⁾	1000 ³⁾	1300 ⁴⁾
-	42	618	733	1351	1236	²⁾	1050 ³⁾	1365 ⁴⁾
1200	48	696	811	1507	1392	²⁾	1200 ³⁾	1560 ⁴⁾
-	54	809	924	1733	1617	²⁾	1350 ³⁾	1755 ⁴⁾
1400	-	809	924	1733	1617	²⁾	1400 ³⁾	1820 ⁴⁾
-	60	909	1024	1933	1817	²⁾	1500 ³⁾	1950 ⁴⁾
1600	-	909	1024	1933	1817	²⁾	1600 ³⁾	2080 ⁴⁾
-	66	960	1075	2035	1919	²⁾	1650 ³⁾	2145 ⁴⁾
1800	72	1016	1131	2147	2032	²⁾	1800 ³⁾	2340 ⁴⁾
-	78	1127	1242	2369	2254	²⁾	2000 ³⁾	2600 ⁴⁾
2000	-	1127	1242	2369	2254	²⁾	2000 ³⁾	2600 ⁴⁾

- 1) The dimensions are reference values. They may vary depending on the pressure rating, design and order option.
- 2) Internal diameter depends on the liner, see the measuring tube specification → 90
- 3) Order code for "Design", option F "Fixed flange, short installed length" and option J "Fixed flange, short installed length, 0 x DN inlet/outlet runs"
- 4) Order code for "Design", option G "Fixed flange, long installed length" and option K "Fixed flange, long installed length 0 x DN inlet/outlet runs"

DN 2200 to 3000 mm (84 to 120 in)

DN		Order code for "Design"				K	L
		Option F, J					
		D ¹⁾	E ¹⁾	F ¹⁾	M ¹⁾		
[mm]	[in]	[mm]	[mm]	[mm]	[mm]	[mm]	[mm]
-	84	1227	1342	2569	2454	²⁾	2200
2200	-	1227	1342	2569	2454	²⁾	2200
-	90	1332	1447	2779	2664	²⁾	2400
2400	-	1332	1447	2783	2664	²⁾	2400
-	96	1431	1546	2977	2861	²⁾	2450

DN		Order code for "Design"					K	L
		Option F, J						
[mm]	[in]	D ¹⁾ [mm]	E ¹⁾ [mm]	F ¹⁾ [mm]	M ¹⁾ [mm]	[mm]	[mm]	
-	102	1516	1631	3147	3032	²⁾	2600	
2600	-	1442	1557	2999	2883	²⁾	2600	
-	108	1602	1718	3320	3204	²⁾	2750	
2800	-	1547	1662	3209	3093	²⁾	2800	
-	114	1688	1803	3491	3375	²⁾	2900	
3000	-	1647	1762	3409	3293	²⁾	3000	
-	120	1774	1889	3663	3547	²⁾	3050	

- 1) The dimensions are reference values. They may vary depending on the pressure rating, design and order option.
- 2) Internal diameter depends on the liner, see the measuring tube specification →  90

Flange connections

Fixed flange

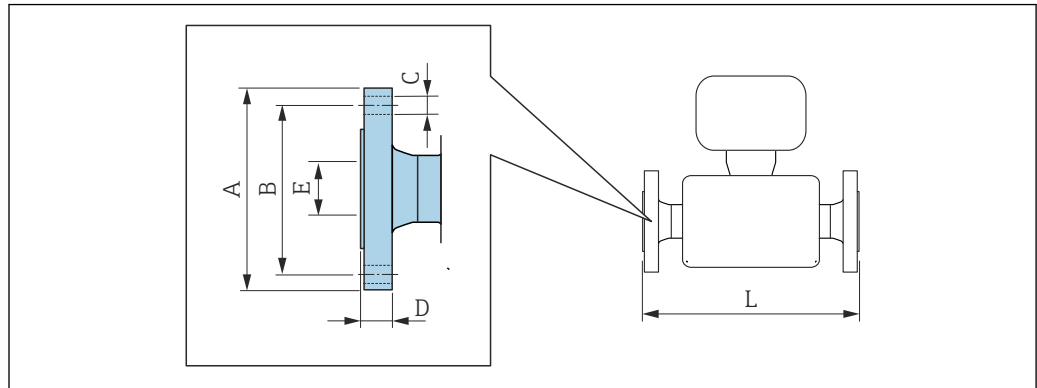

A0015621

Flange in accordance with EN 1092-1 (DIN 2501 / DIN 2512N): PN 6

Carbon steel: order code for "Process connection", option D1K

Stainless steel: order code for "Process connection", option D1S

DN [mm]	A [mm]	B [mm]	C [mm]	D [mm]	E [mm]	L [mm]
350	490	445	12 × Ø22	22	1)	2)
400	540	495	16 × Ø22	22		
450	595	565	20 × Ø26	26		
500	645	600	20 × Ø22	24		
600	755	705	20 × Ø26	30		
700	860	810	24 × Ø26	30		
800	975	920	24 × Ø30	30		
900	1075	1020	24 × Ø30	34		
1000	1175	1120	28 × Ø30	38		
1200	1405	1340	32 × Ø33	42		
1400	1630	1560	36 × Ø36	56		
1600	1830	1760	40 × Ø36	63		
1800	2045	1970	44 × Ø39	69		
2000	2265	2180	48 × Ø42	74		
2200	2475	2390	52 × Ø42	81		
2400	2685	2600	56 × Ø42	87		
2600	2905	2810	60 × Ø48	91		
2800	3115	3020	64 × Ø48	101		
3000	3315	3220	68 × Ø48	102		

Surface roughness (flange): EN 1092-1 Form B1 (DIN 2526 Form C), Ra 6.3 to 12.5 µm

1) Depends on the liner → ☞ 90

2) Total installed length is independent of the process connections. Length according to DVGW (German Technical and Scientific Association for Gas and Water) → ☞ 54 (compact version) → ☞ 58 (remote version)

Flange in accordance with EN 1092-1 (DIN 2501 / DIN 2512N): PN 10						
Carbon steel: order code for "Process connection", option D2K						
Stainless steel: order code for "Process connection", option D2S						
DN	A	B	C	D	E	L
[mm]	[mm]	[mm]	[mm]	[mm]	[mm]	[mm]
200	340	295	8 × Ø22	26	1)	2)
250	395	350	12 × Ø22	28		
300	445	400	12 × Ø22	28		
350	505	460	16 × Ø22	26		
400	565	515	16 × Ø26	26		
450	615	565	20 × Ø26	26		
500	670	620	20 × Ø26	28		
600	780	725	20 × Ø30	30		
700	895	840	24 × Ø30	35		
800	1015	950	24 × Ø33	38		
900	1115	1050	28 × Ø33	38		
1000	1230	1160	28 × Ø36	44		
1200	1455	1380	32 × Ø39	55		
1400	1675	1590	36 × Ø42	65		
1600	1915	1820	40 × Ø48	75		
1800	2115	2020	44 × Ø48	85		
2000	2325	2230	48 × Ø48	90		
2200	2550	2440	52 × Ø56	100		
2400	2760	2650	56 × Ø56	110		
2600	2960	2850	60 × Ø56	110		
2800	3180	3070	64 × Ø56	124		
3000	3405	3290	68 × Ø62	132		

Surface roughness (flange): EN 1092-1 Form B1 (DIN 2526 Form C), Ra 6.3 to 12.5 µm

- 1) Depends on the liner → ☞ 90
- 2) Total installed length is independent of the process connections. Length according to DVGW (German Technical and Scientific Association for Gas and Water) → ☞ 54 (compact version) → ☞ 58 (remote version)

Flange in accordance with EN 1092-1 (DIN 2501 / DIN 2512N): PN 16						
Carbon steel: order code for "Process connection", option D3K						
Stainless steel: order code for "Process connection", option D3S						
DN	A	B	C	D	E	L
[mm]	[mm]	[mm]	[mm]	[mm]	[mm]	[mm]
65	185	145	8 × Ø18	20	1)	2)
80	200	160	8 × Ø18	20		
100	220	180	8 × Ø18	22		
125	250	210	8 × Ø18	24		
150	285	240	8 × Ø22	24		
200	340	295	12 × Ø22	26		
250	405	355	12 × Ø26	32		
300	460	410	12 × Ø26	32		

Flange in accordance with EN 1092-1 (DIN 2501 / DIN 2512N): PN 16						
Carbon steel: order code for "Process connection", option D3K						
Stainless steel: order code for "Process connection", option D3S						
DN [mm]	A [mm]	B [mm]	C [mm]	D [mm]	E [mm]	L [mm]
350	520	470	16 × Ø26	30		
400	580	525	16 × Ø30	32		
450	640	585	20 × Ø30	34		
500	715	650	20 × Ø33	36		
600	840	770	20 × Ø36	40		
700	910	840	24 × Ø36	40		
800	1025	950	24 × Ø39	41		
900	1125	1050	28 × Ø39	48		
1000	1255	1170	28 × Ø42	59		
1200	1485	1390	32 × Ø48	78		
1400	1685	1590	36 × Ø48	84		
1600	1930	1820	40 × Ø56	102		
1800	2130	2020	44 × Ø56	110		
2000	2345	2230	48 × Ø62	124		
Surface roughness (flange): EN 1092-1 Form B1 (DIN 2526 Form C), Ra 6.3 to 12.5 µm						

- 1) Depends on the liner → 90
- 2) Total length is independent of the process connections. Length according to DVGW (German Technical and Scientific Association for Gas and Water) → 54 (compact version) → 58 (remote version)

Flange in accordance with EN 1092-1 (DIN 2501 / DIN 2512N): PN 25						
Carbon steel: order code for "Process connection", option D4K						
Stainless steel: order code for "Process connection", option D4S						
DN [mm]	A [mm]	B [mm]	C [mm]	D [mm]	E [mm]	L [mm]
200	360	310	12 × Ø26	32	1)	2)
250	425	370	12 × Ø30	36		
300	485	430	16 × Ø30	40		
350	555	490	16 × Ø33	38		
400	620	550	16 × Ø36	40		
450	670	600	20 × Ø36	46		
500	730	660	20 × Ø36	48		
600	845	770	20 × Ø39	48		
700	960	875	24 × Ø42	50		
800	1085	990	24 × Ø48	53		
900	1185	1090	28 × Ø48	57		
1000	1320	1210	28 × Ø56	63		
Surface roughness (flange): EN 1092-1 Form B1 (DIN 2526 Form C), Ra 6.3 to 12.5 µm						

- 1) Depends on the liner → 90
- 2) Total length is independent of the process connections. Length according to DVGW (German Technical and Scientific Association for Gas and Water) → 54 (compact version) → 58 (remote version)

Flange in accordance with EN 1092-1 (DIN 2501 / DIN 2512N): PN 40						
Carbon steel: order code for "Process connection", option D5K						
Stainless steel: order code for "Process connection", option D5S						
DN [mm]	A [mm]	B [mm]	C [mm]	D [mm]	E [mm]	L [mm]
25	115	85	4 × Ø14	16	1)	2)
32	140	100	4 × Ø18	18		
40	150	110	4 × Ø18	18		
50	165	125	4 × Ø18	20		
65	185	145	8 × Ø18	24		
80	200	160	8 × Ø18	26		
100	235	190	8 × Ø22	26		
125	270	220	8 × Ø26	28		
150	300	250	8 × Ø26	30		
Surface roughness (flange): EN 1092-1 Form B1 (DIN 2526 Form C), Ra 6.3 to 12.5 µm						

- 1) Depends on the liner → 90
- 2) Total length is independent of the process connections. Length according to DVGW (German Technical and Scientific Association for Gas and Water) → 54 (compact version) → 58 (remote version)

Flange according to ASME B16.5, Class 150							
Carbon steel: order code for "Process connection", option A1K							
Stainless steel: order code for "Process connection", option A1S							
DN		A	B	C	D	E	L
[mm]	[in]	[mm]	[mm]	[mm]	[mm]	[mm]	[mm]
25	1	108	79.2	4 × Ø16	12.6	1)	2)
40	1 ½	127	98.6	4 × Ø16	15.9		
50	2	152.4	120.7	4 × Ø19.1	17.5		
80	3	190.5	152.4	4 × Ø19.1	22.3		
100	4	228.6	190.5	8 × Ø19.1	22.3		
150	6	279.4	241.3	8 × Ø22.4	23.8		
200	8	342.9	298.5	8 × Ø22.4	26.8		
250	10	406.4	362	12 × Ø25.4	29.6		
300	12	482.6	431.8	12 × Ø25.4	30.2		
350	14	535	476.3	12 × Ø28.6	35.4		
400	16	595	539.8	16 × Ø28.6	37		
450	18	635	577.9	16 × Ø31.8	40.1		
500	20	700	635	20 × Ø31.8	43.3		
600	24	815	749.3	20 × Ø34.9	48.1		
Surface roughness (flange): Ra 6.3 to 12.5 µm							

- 1) Depends on the liner → 90
- 2) Total length is independent of the process connections. Length according to DVGW (German Technical and Scientific Association for Gas and Water) → 54 (compact version) → 58 (remote version)

Flange according to ASME B16.5, Class 300							
Carbon steel: order code for "Process connection", option A2K							
Stainless steel: order code for "Process connection", option A2S							
DN		A	B	C	D	E	L
[mm]	[in]	[mm]	[mm]	[mm]	[mm]	[mm]	[mm]
25	1	123.9	88.9	4 × Ø19.1	15.9	1)	2)
40	1 ½	155.4	114.3	4 × Ø22.4	19		
50	2	165.1	127	8 × Ø19.1	20.8		
80	3	209.6	168.1	8 × Ø22.4	26.8		
100	4	254	200.2	8 × Ø22.4	30.2		
150	6	317.5	269.7	12 × Ø22.4	35		

Surface roughness (flange): Ra 6.3 to 12.5 µm

- 1) Depends on the liner → ☞ 90
 2) Total length is independent of the process connections. Length according to DVGW (German Technical and Scientific Association for Gas and Water) → ☞ 54 (compact version) → ☞ 58 (remote version)

Flange according to JIS B2220, 10K						
Carbon steel: order code for "Process connection", option N3K						
Stainless steel: order code for "Process connection", option N3S						
DN	A	B	C	D	E	L
[mm]	[mm]	[mm]	[mm]	[mm]	[mm]	[mm]
50	155	120	4 × Ø19	16	1)	2)
65	175	140	4 × Ø19	18		
80	185	150	8 × Ø19	18		
100	210	175	8 × Ø19	18		
125	250	210	8 × Ø23	20		
150	280	240	8 × Ø23	22		
200	330	290	12 × Ø23	22		
250	400	355	12 × Ø25	24		
300	445	400	16 × Ø25	24		

Surface roughness (flange): Ra 6.3 to 12.5 µm

- 1) Depends on the liner → ☞ 90
 2) Total length is independent of the process connections. Length according to DVGW (German Technical and Scientific Association for Gas and Water) → ☞ 54 (compact version) → ☞ 58 (remote version)

Flange according to JIS B2220, 20K						
Carbon steel: order code for "Process connection", option N4K						
Stainless steel: order code for "Process connection", option N4S						
DN	A	B	C	D	E	L
[mm]	[mm]	[mm]	[mm]	[mm]	[mm]	[mm]
25	125	90	4 × Ø19	16	1)	2)
32	135	100	4 × Ø19	18		
40	140	105	4 × Ø19	18		
50	155	120	8 × Ø19	18		
65	175	140	8 × Ø19	20		
80	200	160	8 × Ø23	22		
100	225	185	8 × Ø23	24		

Flange according to JIS B2220, 20K						
Carbon steel: order code for "Process connection", option N4K						
Stainless steel: order code for "Process connection", option N4S						
DN [mm]	A [mm]	B [mm]	C [mm]	D [mm]	E [mm]	L [mm]
125	270	225	8 × Ø25	26		
150	305	260	12 × Ø25	28		
200	350	305	12 × Ø25	30		
250	430	380	12 × Ø27	34		
300	480	430	16 × Ø27	36		
Surface roughness (flange): Ra 6.3 to 12.5 µm						

- 1) Depends on the liner → ☞ 90
- 2) Total length is independent of the process connections. Length according to DVGW (German Technical and Scientific Association for Gas and Water) → ☞ 54 (compact version) → ☞ 58 (remote version)

Flange according to AWWA, Class D							
Order code for "Process connection", option W1K							
DN		A	B	C	D	E	L
[mm]	[in]	[mm]	[mm]	[mm]	[mm]	[mm]	[mm]
700	28	927	863.6	28 × Ø35	33.4	1)	2)
750	30	984	914.4	28 × Ø35	35.0		
800	32	1060	977.9	28 × Ø42	38.1		
900	36	1168	1085.9	32 × Ø42	41.3		
1000	40	1289	1200.2	36 × Ø42	41.3		
-	42	1346	1257.3	36 × Ø42	44.5		
1200	48	1511	1422.4	44 × Ø42	47.7		
-	54	1683	1593.9	44 × Ø48	54.0		
-	60	1855	1759.0	52 × Ø48	57.2		
-	66	2032	1930.4	52 × Ø48	63.5		
1800	72	2197	2095.5	60 × Ø48	66.7		
-	78	2362	2260.6	64 × Ø54	69.9		
-	84	2535	2425.7	64 × Ø54	73.1		
-	90	2705	2717.8	68 × Ø60	76.2		
-	96	2877	2755.9	68 × Ø60.3	82.55		
-	102	3048	2908.3	68 × Ø66.7	82.55		
-	108	3219	3067.0	68 × Ø66.7	85.73		
-	114	3391	3219.5	68 × Ø73	88.90		
-	120	3562	3371.8	68 × Ø73	88.90		
Surface roughness (flange): Ra 6.3 to 12.5 µm							

- 1) Depends on the liner → ☞ 90
- 2) Total length is independent of the process connections. Installed length according to DVGW → ☞ 54 (compact version) → ☞ 58 (remote version)

Flange according to AS 2129, Tab. E						
<i>Order code for "Process connection", option M2K</i>						
DN [mm]	A [mm]	B [mm]	C [mm]	D [mm]	E [mm]	L [mm]
80	185	146	4 × Ø18	12	1)	2)
100	215	178	8 × Ø18	13		
150	280	235	8 × Ø22	17		
200	335	292	8 × Ø22	19		
250	405	356	12 × Ø22	22		
300	455	406	12 × Ø26	25		
350	525	470	12 × Ø26	30		
400	580	521	12 × Ø26	32		
450	640	584	16 × Ø26	35		
500	705	641	16 × Ø26	38		
600	825	756	16 × Ø33	48		
700	910	845	20 × Ø33	51		
750	995	927	20 × Ø36	54		
800	1060	984	20 × Ø36	54		
900	1175	1092	24 × Ø36	64		
1000	1255	1175	24 × Ø39	67		
1200	1490	1410	32 × Ø39	79		
Surface roughness (flange): Ra 6.3 to 12.5 µm						

1) Depends on the liner → ☹ 90

2) Total length is independent of the process connections. Length according to DVGW (German Technical and Scientific Association for Gas and Water) → ☹ 54 (compact version) → ☹ 58 (remote version)

Flange according to AS 4087, PN 16						
<i>Order code for "Process connection", option M3K</i>						
DN [mm]	A [mm]	B [mm]	C [mm]	D [mm]	E [mm]	L [mm]
80	185	146	4 × Ø18	12	1)	2)
100	215	178	4 × Ø18	13		
150	280	235	8 × Ø18	13		
200	335	292	8 × Ø18	19		
250	405	356	8 × Ø22	19		
300	455	406	12 × Ø22	23		
350	525	470	12 × Ø26	30		
375	550	495	12 × Ø26	30		
400	580	521	12 × Ø26	32		
450	640	584	12 × Ø26	30		
500	705	641	16 × Ø26	38		
600	825	756	16 × Ø30	48		
700	910	845	20 × Ø30	56		
750	995	927	20 × Ø33	56		
800	1060	984	20 × Ø36	56		

Flange according to AS 4087, PN 16						
<i>Order code for "Process connection", option M3K</i>						
DN [mm]	A [mm]	B [mm]	C [mm]	D [mm]	E [mm]	L [mm]
900	1175	1092	24 × Ø36	66		
1000	1255	1175	24 × Ø36	66		
1200	1490	1410	32 × Ø36	76		

Surface roughness (flange): Ra 6.3 to 12.5 µm

- 1) Depends on the liner → 90
- 2) Total length is independent of the process connections. Length according to DVGW (German Technical and Scientific Association for Gas and Water) → 54 (compact version) → 58 (remote version)

Lap joint flange

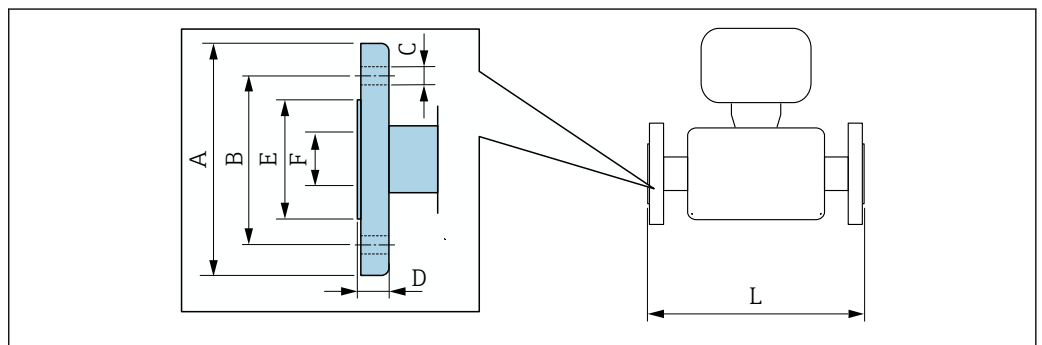

A0037862

Lap joint flange in accordance with EN 1092-1 (DIN 2501 / DIN 2512N): PN 10								
Carbon steel: order code for "Process connection", option D22								
Stainless steel: order code for "Process connection", option D24								
DN		A	B	C	D	E	F	L
[mm]	[in]	[mm]	[mm]	[mm]	[mm]	[mm]	[mm]	[mm]
200	8	340	295	8 × Ø22	24	264	1)	2)
250	10	395	350	12 × Ø22	26	317		
300	12	445	400	12 × Ø22	26	367		

Surface roughness (flange): Ra 6.3 to 12.5 µm

- 1) Depends on the liner → 90
- 2) Total length is independent of the process connections. Length according to DVGW (German Technical and Scientific Association for Gas and Water) → 54 (compact version) → 58 (remote version)

Lap joint flange in accordance with EN 1092-1 (DIN 2501 / DIN 2512N): PN 16								
Carbon steel: order code for "Process connection", option D32								
Stainless steel: order code for "Process connection", option D34								
DN		A	B	C	D	E	F	L
[mm]	[in]	[mm]	[mm]	[mm]	[mm]	[mm]	[mm]	[mm]
25	1	115	85	4 × Ø14	16	49	1)	2)
32	-	140	100	4 × Ø18	18	65		
40	1 ½	150	110	4 × Ø18	18	71		
50	2	165	125	4 × Ø18	20	88		
65	-	185	145	8 × Ø18	20	103		
80	3	200	160	8 × Ø18	20	120		

Lap joint flange in accordance with EN 1092-1 (DIN 2501 / DIN 2512N): PN 16
Carbon steel: order code for "Process connection", option D32
Stainless steel: order code for "Process connection", option D34

DN		A	B	C	D	E	F	L
[mm]	[in]	[mm]	[mm]	[mm]	[mm]	[mm]	[mm]	[mm]
100	4	220	180	8 × Ø18	22	148		
125	-	250	210	8 × Ø18	22	177		
150	6	285	240	8 × Ø22	24	209		
200	8	340	295	12 × Ø22	26	264		
250	10	405	355	12 × Ø26	29	317		
300	12	460	410	12 × Ø26	32	367		

Surface roughness (flange): Ra 6.3 to 12.5 µm

- 1) Depends on the liner → ☞ 90
- 2) Total length is independent of the process connections. Length according to DVGW (German Technical and Scientific Association for Gas and Water) → ☞ 54 (compact version) → ☞ 58 (remote version)

Lap joint flange according to ASME B16.5, Class 150
Carbon steel: order code for "Process connection", option A12
Stainless steel: order code for "Process connection", option A14

DN		A	B	C	D	E	F	L
[mm]	[in]	[mm]	[mm]	[mm]	[mm]	[mm]	[mm]	[mm]
25	1	110	80	4 × Ø16	14	49	1)	2)
40	1 ½	125	98	4 × Ø16	17.5	71		
50	2	150	121	4 × Ø19	19	88		
80	3	190	152	4 × Ø19	24	120		
100	4	230	190	8 × Ø19	24	148		
150	6	280	241	8 × Ø23	25	209		
200	8	345	298	8 × Ø23	29	264		
250	10	405	362	12 × Ø25	30	317		
300	12	485	432	12 × Ø25	32	378		

Surface roughness (flange): Ra 6.3 to 12.5 µm

- 1) Depends on the liner → ☞ 90
- 2) Total length is independent of the process connections. Length according to DVGW (German Technical and Scientific Association for Gas and Water) → ☞ 54 (compact version) → ☞ 58 (remote version)

Lap joint flange, stamped plate

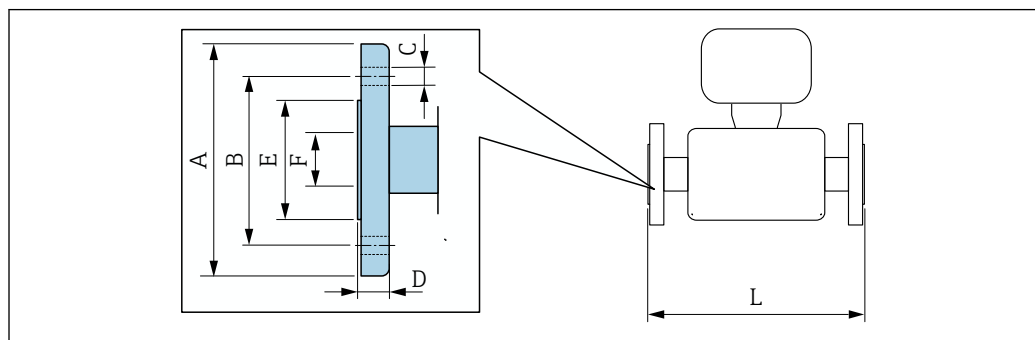

A0037862

Lap joint flange, stamped plate in accordance with EN 1092-1 (DIN 2501 / DIN 2512N): PN 10
Carbon steel: order code for "Process connection", option D21
Stainless steel: order code for "Process connection", option D23

DN [mm]	A [mm]	B [mm]	C [mm]	D [mm]	E [mm]	F [mm]	L [mm]
25	115	85	4 x Ø13.5	16.5	49	1)	2)
32	140	100	4 x Ø17.5	17	65		
40	150	110	4 x Ø17.5	16.5	71		
50	165	125	4 x Ø17.5	18.5	88		
65	185	145	4 x Ø17.5	20	103		
80	200	160	8 x Ø17.5	23.5	120		
100	220	180	8 x Ø17.5	24.5	148		
125	250	210	8 x Ø17.5	24	177		
150	285	240	8 x Ø21.5	25	209		
200	340	295	8 x Ø21.5	27.5	264		
250	405	350	12 x Ø21.5	30.5	317		
300	445	400	12 x Ø21.5	34.5	367		

Surface roughness (flange): Ra 6.3 to 12.5 µm

- 1) Depends on the liner → ☹ 90
- 2) Total length is independent of the process connections. Length according to DVGW (German Technical and Scientific Association for Gas and Water) → ☹ 54 (compact version) → ☹ 58 (remote version)

Accessories

Ground disks for flange connections

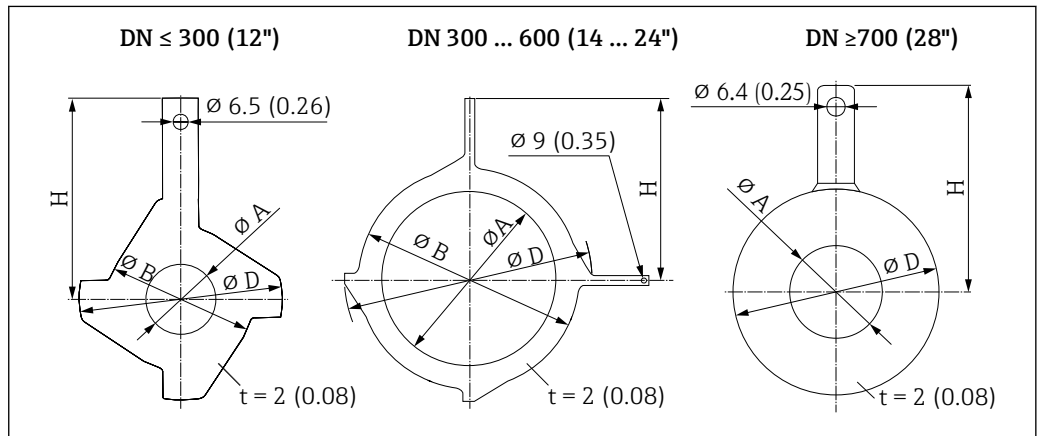

A0015442

DN		Pressure rating	A		B		D		H	
[mm]	[inch]		[mm]	[inch]	[mm]	[inch]	[mm]	[inch]	[mm]	[inch]
25	1"	1)	26	1.02	62	2.44	77.5	3.05	87.5	3.44
32	1 ¼"	1)	35	1.38	80	3.15	87.5	3.44	94.5	3.72
40	1 ½"	1)	41	1.61	82	3.23	101	3.98	103	4.06
50	2"	1)	52	2.05	101	3.98	115.5	4.55	108	4.25
65	2 ½"	1)	68	2.68	121	4.76	131.5	5.18	118	4.65
80	3"	1)	80	3.15	131	5.16	154.5	6.08	135	5.31

DN		Pressure rating	A		B		D		H	
[mm]	[inch]		[mm]	[inch]	[mm]	[inch]	[mm]	[inch]	[mm]	[inch]
100	4"	1)	104	4.09	156	6.14	186.5	7.34	153	6.02
125	5"	1)	130	5.12	187	7.36	206.5	8.13	160	6.30
150	6"	1)	158	6.22	217	8.54	256	10.08	184	7.24
200	8"	1)	206	8.11	267	10.51	288	11.34	205	8.07
250	10"	1)	260	10.2	328	12.91	359	14.13	240	9.45
300	12"	PN 10 PN 16 Cl. 150	312	12.3	375	14.76	413	16.26	273	10.75
		PN 25 JIS 10K JIS 20K	310	12.2	375	14.76	404	15.91	268	10.55
350	14"	PN 6	420	16.5	420	16.54	479	18.86	365	14.37
		PN 10								
		PN 16								
375	15"	PN 16	461	18.2	461	18.2	523	20.6	395	15.6
400	16"	PN 6	470	18.5	470	18.50	542	21.34	395	15.55
		PN 10								
		PN 16								
450	18"	PN 6	525	20.7	525	20.67	583	22.95	417	16.42
		PN 10								
		PN 16								
500	20"	PN 6	575	22.6	575	22.64	650	25.59	460	18.11
		PN 10								
		PN 16								
600	24"	PN 6	676	26.6	676	26.61	766	30.16	522	20.55
		PN 10								
		PN 16								
700	28"	PN 6	697	27.4	-	-	786	30.94	460	18.11
		PN10	693	27.3	-	-	813	32.01	480	18.9
		PN16	687	27.1	-	-	807	31.77	490	19.29
		Cl, D	693	27.3	-	-	832	32.76	494	19.45
750	30"	Cl, D	743	29.3	-	-	833	32.8	523	20.59
800	32"	PN 6	799	31.5	-	-	893	35.16	520	20.47
		PN 10	795	31.3	-	-	920	36.22	540	21.26
		PN 16	789	31.1	-	-	914	35.98	550	21.65
		Cl, D	795	31.3	-	-	940	37.01	561	22.09
900	36"	PN 6	897	35.3	-	-	993	39.09	570	22.44
		PN 10	893	35.2	-	-	1020	40.16	590	23.23
		PN 16	886	34.9	-	-	1014	39.92	595	23.43
		Cl, D	893	35.2	-	-	1048	41.26	615	24.21
1000	40"	PN 6	999	39.3	-	-	1093	43.03	620	24.41
		PN 10	995	39.2	-	-	1127	44.37	650	25.59
		PN 16	988	38.9	-	-	1131	44.53	660	25.98

DN		Pressure rating	A		B		D		H	
[mm]	[inch]		[mm]	[inch]	[mm]	[inch]	[mm]	[inch]	[mm]	[inch]
		Cl, D	995	39.2	-	-	1163	45.79	675	26.57
-	42"	PN 6	1044	41.1	-	-	1220	48.03	704	27.72
1200	48"	PN 6	1203	47.4	-	-	1310	51.57	733	28.86
		PN 10	1196	47.1	-	-	1344	52.91	760	29.92
		PN 16	1196	47.1	-	-	1385	54.53	786	30.94
		Cl, D	1188	46.8	-	-	1345	52.95	775	30.51

- 1) In the case of DN 25 to 250, ground disks can be used for all the flange standards/pressure ratings which can be supplied in the standard version

Dimensions in US units

Compact version

Order code for "Housing", option A "Compact, aluminum, coated" or option M "Compact, polycarbonate"

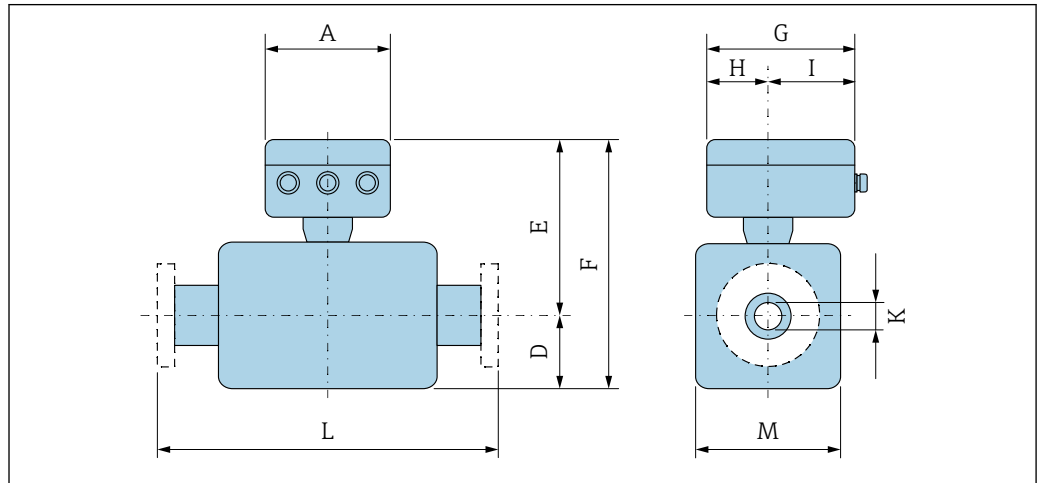

A0033790

A [in]	G ¹⁾ [in]	H [in]	I ¹⁾ [in]
6.57	7.60	3.54	4.06

1) Depending on the cable gland used: values up to + 1.18 in

DN 1 to 12 in (25 to 300 mm): Sensor with aluminum half-shell housing

DN		Order code for "Design"									
		Options D, E, H, I				Option C				K	L
[mm]	[in]	D ¹⁾ [in]	E ¹⁾ [in]	F ¹⁾ [in]	M ¹⁾ [in]	D ¹⁾ [in]	E ¹⁾ [in]	F ¹⁾ [in]	M ¹⁾ [in]		
25	1	3.31	7.91	11.22	4.72	-	-	-	-	2)	7.87
32	-	3.31	7.91	11.22	4.72	-	-	-	-	2)	7.87
40	1 ½	3.31	7.91	11.22	4.72	-	-	-	-	2)	7.87
50	2	3.31	7.91	11.22	4.72	3.31	7.91	11.22	4.72	2)	7.87
65	-	4.29	8.9	13.19	7.09	3.31	7.91	11.22	4.72	2)	7.87
80	3	4.29	8.9	13.19	7.09	3.31	7.91	11.22	4.72	2)	7.87
100	4	4.29	8.9	13.19	7.09	4.29	8.9	13.19	7.09	2)	9.84
125	-	5.91	10.47	16.38	10.24	4.29	8.9	13.19	7.09	2)	9.84
150	6	5.91	10.47	16.38	10.24	4.29	8.9	13.19	7.09	2)	11.81
200	8	7.09	11.46	18.54	12.76	5.91	10.47	16.38	10.24	2)	13.78
250	10	8.07	12.44	20.51	15.75	5.91	10.47	16.38	10.24	2)	17.72
300	12	9.06	13.43	22.48	18.11	7.09	11.46	18.54	12.76	2)	19.69

1) The dimensions are reference values. They may vary depending on the pressure rating, design and order option.

2) Depends on the liner → 90

DN 14 to 16 in (350 to 400 mm)

DN		Order code for "Design"				K	L
		Options E, I					
[mm]	[in]	D ¹⁾ [in]	E ¹⁾ [in]	F ¹⁾ [in]	M ¹⁾ [in]	[in]	[in]
350	14	11.10	15.63	26.73	22.20	²⁾	21.65
375	15	12.13	16.65	28.78	24.25	²⁾	23.62
400	16	12.13	16.65	28.78	24.25	²⁾	23.62

- 1) The dimensions are reference values. They may vary depending on the pressure rating, design and order option.
- 2) Depends on the liner → ☞ 90

DN 18 to 36 in (450 to 900 mm)

DN		Order code for "Design"								K	L	
		Options F, J				Options G, K						
[mm]	[in]	D ¹⁾ [in]	E ¹⁾ [in]	F ¹⁾ [in]	M ¹⁾ [in]	D ¹⁾ [in]	E ¹⁾ [in]	F ¹⁾ [in]	M ¹⁾ [in]	[in]	[in]	[in]
450	18	11.42	15.94	27.36	22.83	13.11	17.64	30.75	26.22	²⁾	23.62 ³⁾	25.59 ⁴⁾
500	20	12.40	16.93	29.33	24.80	14.13	18.66	32.80	28.23	²⁾	23.62 ²⁾	25.59 ⁴⁾
600	24	14.37	18.90	33.27	28.74	16.18	20.71	36.89	32.32	²⁾	23.62 ²⁾	30.71 ⁴⁾
700	28	16.77	21.30	38.07	33.50	20.16	24.69	44.84	40.31	²⁾	27.56 ²⁾	35.83 ⁴⁾
750	30	18.23	22.76	40.98	36.46	20.16	24.69	44.84	40.31	²⁾	29.53 ²⁾	38.39 ⁴⁾
800	32	18.98	23.50	42.48	37.95	21.02	25.55	46.57	41.93	²⁾	31.5 ²⁾	40.94 ⁴⁾
900	36	20.94	25.47	46.42	41.89	24.02	28.54	52.56	47.95	²⁾	35.43 ²⁾	46.06 ⁴⁾

- 1) The dimensions are reference values. They may vary depending on the pressure rating, design and order option.
- 2) Depends on the liner → ☞ 90
- 3) Order code for "Design", option F "Fixed flange, short installed length" and option J "Fixed flange, short installed length, 0 x DN inlet/outlet runs"
- 4) Order code for "Design", option G "Fixed flange, long installed length" and option K "Fixed flange, long installed length 0 x DN inlet/outlet runs"

DN 40 to 78 in (1000 to 2000 mm)

DN		Order code for "Design"				K	L	
		Options F, G, J, K						
[mm]	[in]	D ¹⁾ [in]	E ¹⁾ [in]	F ¹⁾ [in]	M ¹⁾ [in]	[in]	[in]	[in]
1000	40	22.91	27.44	50.35	45.83	²⁾	39.37 ³⁾	51.18 ⁴⁾
-	42	24.33	28.86	53.19	48.66	²⁾	41.34 ³⁾	53.74 ⁴⁾
1200	48	27.40	31.93	59.33	54.80	²⁾	47.24 ³⁾	61.42 ⁴⁾
-	54	31.85	36.38	68.23	63.66	²⁾	53.15 ³⁾	69.09 ⁴⁾
1400	-	31.85	36.38	68.23	63.66	²⁾	55.12 ³⁾	71.65 ⁴⁾
-	60	35.79	40.31	76.10	71.54	²⁾	59.06 ³⁾	76.77 ⁴⁾
1600	-	35.79	40.31	76.10	71.54	²⁾	62.99 ³⁾	81.89 ⁴⁾
-	66	37.80	42.32	80.12	75.55	²⁾	64.96 ³⁾	84.45 ⁴⁾
1800	72	40.00	44.53	84.53	80.00	²⁾	70.87 ³⁾	92.13 ⁴⁾

DN		Order code for "Design"					K	L	
		Options F, G, J, K							
[mm]	[in]	D ¹⁾ [in]	E ¹⁾ [in]	F ¹⁾ [in]	M ¹⁾ [in]	[in]	[in]	[in]	
-	78	44.37	48.90	93.27	88.74	²⁾	78.74 ³⁾	102.36 ⁴⁾	
2000	-	44.37	48.90	93.27	88.74	²⁾	78.74 ³⁾	102.36 ⁴⁾	

- 1) The dimensions are reference values. They may vary depending on the pressure rating, design and order option.
- 2) Depends on the liner → 90
- 3) Order code for "Design", option F "Fixed flange, short installed length" and option J "Fixed flange, short installed length, 0 x DN inlet/outlet runs"
- 4) Order code for "Design", option G "Fixed flange, long installed length" and option K "Fixed flange, long installed length 0 x DN inlet/outlet runs"

DN 84 to 120 in (2200 to 3000 mm)

DN		Order code for "Design"				K	L
		Option F, J					
[mm]	[in]	D ¹⁾ [in]	E ¹⁾ [in]	F ¹⁾ [in]	M ¹⁾ [in]	[in]	[in]
-	84	48.31	52.83	101.14	96.61	²⁾	86.61
2200	-	48.31	52.83	101.14	96.61	²⁾	86.61
-	90	52.44	56.97	109.41	104.88	²⁾	94.49
2400	-	52.44	56.97	109.57	104.88	²⁾	94.49
-	96	56.34	60.87	117.20	112.64	²⁾	96.46
-	102	59.69	64.21	123.90	119.37	²⁾	102.36
2600	-	56.77	61.30	118.07	113.50	²⁾	102.36
-	108	63.07	67.64	130.71	126.14	²⁾	108.27
2800	-	60.91	65.43	126.34	121.77	²⁾	110.24
-	114	66.46	70.98	137.44	132.87	²⁾	114.17
3000	-	64.84	69.37	134.21	129.65	²⁾	118.11
-	120	69.84	74.37	144.21	139.65	²⁾	120.08

- 1) The dimensions are reference values. They may vary depending on the pressure rating, design and order option.
- 2) Depends on the liner → 90

Remote version

Transmitter remote version

Order code for "Housing", option N "Remote, polycarbonate" or option P "Remote, aluminum coated"

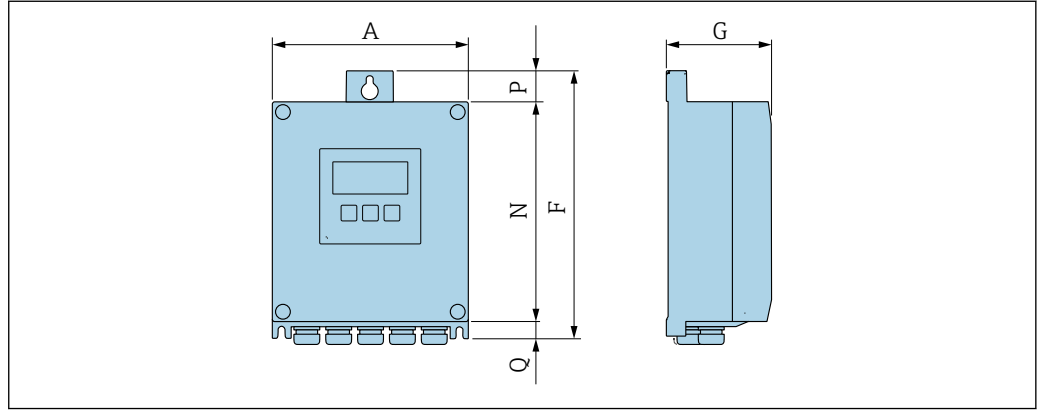

A0033789

Order code for "Transmitter housing", option P "Remote, aluminum, coated"

A [in]	F [in]	G [in]	N [in]	P [in]	Q [in]
6.57	9.13	3.15	7.36	0.94	0.83

Order code for "Transmitter housing", option N "Remote, polycarbonate"

A [in]	F [in]	G [in]	N [in]	P [in]	Q [in]
6.97	9.21	3.54	7.76	0.67	0.87

Sensor connection housing

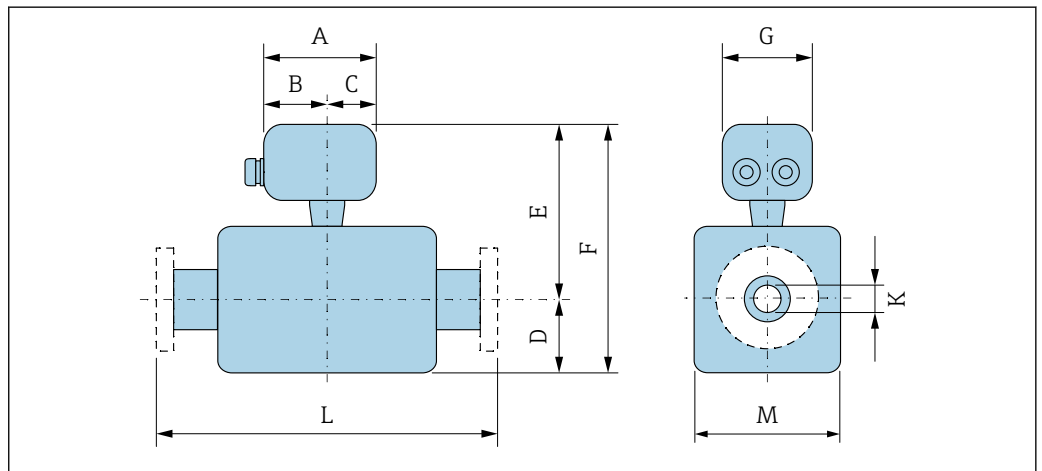

A0033784

Aluminum, coated

A [in]	B [in]	C [in]	G [in]
5.83	3.7	2.13	5.35

Polycarbonate (only in conjunction with order code for "Sensor option", options CA...CE)

A [in]	B [in]	C [in]	G [in]
4.45	2.44	2.01	4.41

DN 1 to 12 in (25 to 300 mm): Sensor with aluminum half-shell housing

DN		Order code for "Design"								K [in]	L [in]
[mm]	[in]	Options D, E, H, I				Option C					
		D ¹⁾ [in]	E ¹⁾ [in]	F ¹⁾ [in]	M ¹⁾ [in]	D ¹⁾ [in]	E ¹⁾ [in]	F ¹⁾ [in]	M ¹⁾ [in]		
25	1	3.31	7.87	11.18	4.72	-	-	-	-	2)	7.87
32	-	3.31	7.87	11.18	4.72	-	-	-	-	2)	7.87
40	1 ½	3.31	7.87	11.18	4.72	-	-	-	-	2)	7.87
50	2	3.31	7.87	11.18	4.72	3.31	7.87	11.18	4.72	2)	7.87
65	-	4.29	8.86	13.15	7.09	3.31	7.87	11.18	4.72	2)	7.87
80	3	4.29	8.86	13.15	7.09	3.31	7.87	11.18	4.72	2)	7.87
100	4	4.29	8.86	13.15	7.09	4.29	8.86	13.15	7.09	2)	9.84
125	-	5.91	10.43	16.34	10.24	4.29	8.86	13.15	7.09	2)	9.84
150	6	5.91	10.43	16.34	10.24	4.29	8.86	13.15	7.09	2)	11.81
200	8	7.09	11.42	18.5	12.76	5.91	10.43	16.34	10.24	2)	13.78
250	10	8.07	12.4	20.47	15.75	5.91	10.43	16.34	10.24	2)	17.72
300	12	9.06	13.39	22.44	18.11	7.09	11.42	18.5	12.76	2)	19.69

- 1) The dimensions are reference values. They may vary depending on the pressure rating, design and order option.
 2) Depends on the liner → 90

DN 1 to 12 in (25 to 300 mm): Sensor with fully welded carbon steel housing

DN		Order code for "Design"								K [in]	L [in]
[mm]	[in]	Option E				Option C					
		D ¹⁾ [mm]	E ¹⁾ [in]	F ¹⁾ [in]	M ¹⁾ [in]	D ¹⁾ [in]	E ¹⁾ [in]	F ¹⁾ [in]	M ¹⁾ [in]		
25	1	2.76	7.87	10.63	5.51	-	-	-	-	2)	7.87
32	-	2.76	7.87	10.63	5.51	-	-	-	-	2)	7.87
40	1 ½	2.76	7.87	10.63	5.51	-	-	-	-	2)	7.87
50	2	2.76	7.87	10.63	5.51	2.76	7.87	10.63	5.51	2)	7.87
65	-	3.23	8.86	12.09	6.5	2.76	7.87	10.63	5.51	2)	7.87
80	3	3.43	8.86	12.28	6.89	2.76	7.87	10.63	5.51	2)	7.87
100	4	3.94	8.86	12.8	7.87	3.23	8.86	12.09	6.5	2)	9.84
125	-	4.45	10.43	14.88	8.9	3.43	8.86	12.28	6.89	2)	9.84
150	6	5.28	10.43	15.71	10.59	3.94	8.86	12.8	7.87	2)	11.81
200	8	6.3	11.42	17.72	12.6	4.45	10.43	14.88	8.9	2)	13.78

DN		Order code for "Design"								K	L
		Option E				Option C					
[mm]	[in]	D ¹⁾ [mm]	E ¹⁾ [in]	F ¹⁾ [in]	M ¹⁾ [in]	D ¹⁾ [in]	E ¹⁾ [in]	F ¹⁾ [in]	M ¹⁾ [in]	[in]	[in]
250	10	7.6	12.4	20	15.24	5.28	10.43	15.71	10.59	²⁾	17.72
300	12	8.58	13.39	21.97	17.2	6.3	11.42	17.72	12.6	²⁾	19.69

- 1) The dimensions are reference values. They may vary depending on the pressure rating, design and order option.
- 2) Depends on the liner → 90

DN 14 to 16 in (350 to 400 mm)

DN		Order code for "Design"				K	L
		Options E, I					
[mm]	[in]	D ¹⁾ [in]	E ¹⁾ [in]	F ¹⁾ [in]	M ¹⁾ [in]	[in]	[in]
350	14	11.10	15.63	26.73	22.20	²⁾	21.65
375	15	12.13	16.65	28.78	24.25	²⁾	23.62
400	16	12.13	16.65	28.78	24.25	²⁾	23.62

- 1) The dimensions are reference values. They may vary depending on the pressure rating, design and order option.
- 2) Depends on the liner → 90

DN 18 to 36 in (450 to 900 mm)

DN		Order code for "Design"								K	L	
		Options F, J				Options G, K						
[mm]	[in]	D ¹⁾ [in]	E ¹⁾ [in]	F ¹⁾ [in]	M ¹⁾ [in]	D ¹⁾ [in]	E ¹⁾ [in]	F ¹⁾ [in]	M ¹⁾ [in]	[in]	[in]	[in]
450	18	11.42	15.94	27.36	22.83	13.11	17.64	30.75	26.22	²⁾	23.62 ³⁾	25.59 ⁴⁾
500	20	12.40	16.93	29.33	24.80	14.13	18.66	32.80	28.23	²⁾	23.62 ³⁾	25.59 ⁴⁾
600	24	14.37	18.90	33.27	28.74	16.18	20.71	36.89	32.32	²⁾	23.62 ³⁾	30.71 ⁴⁾
700	28	16.77	21.30	38.07	33.50	20.16	24.69	44.84	40.31	²⁾	27.56 ³⁾	35.83 ⁴⁾
750	30	18.23	22.76	40.98	36.46	20.16	24.69	44.84	40.31	²⁾	29.53 ³⁾	38.39 ⁴⁾
800	32	18.98	23.50	42.48	37.95	21.02	25.55	46.57	41.93	²⁾	31.5 ³⁾	40.94 ⁴⁾
900	36	20.94	25.47	46.42	41.89	24.02	28.54	52.56	47.95	²⁾	35.43 ³⁾	46.06 ⁴⁾

- 1) The dimensions are reference values. They may vary depending on the pressure rating, design and order option.
- 2) Depends on the liner → 90
- 3) Order code for "Design", option F "Fixed flange, short installed length" and option J "Fixed flange, short installed length, 0 x DN inlet/outlet runs"
- 4) Order code for "Design", option G "Fixed flange, long installed length" and option K "Fixed flange, long installed length 0 x DN inlet/outlet runs"

DN 40 to 78 in (1000 to 2000 mm)

DN		Order code for "Design"					K	L
		Options F, G, J, K						
[mm]	[in]	D ¹⁾ [in]	E ¹⁾ [in]	F ¹⁾ [in]	M ¹⁾ [in]	[in]	[in]	
1000	40	22.91	27.44	50.35	45.83	2)	39.37 ³⁾	51.18 ⁴⁾
-	42	24.33	28.86	53.19	48.66	2)	41.34 ³⁾	53.74 ⁴⁾
1200	48	27.40	31.93	59.33	54.80	2)	47.24 ³⁾	61.42 ⁴⁾
-	54	31.85	36.38	68.23	63.66	2)	53.15 ³⁾	69.09 ⁴⁾
1400	-	31.85	36.38	68.23	63.66	2)	55.12 ³⁾	71.65 ⁴⁾
-	60	35.79	40.31	76.10	71.54	2)	59.06 ³⁾	76.77 ⁴⁾
1600	-	35.79	40.31	76.10	71.54	2)	62.99 ³⁾	81.89 ⁴⁾
-	66	37.80	42.32	80.12	75.55	2)	64.96 ³⁾	84.45 ⁴⁾
1800	72	40.00	44.53	84.53	80.00	2)	70.87 ³⁾	92.13 ⁴⁾
-	78	44.37	48.90	93.27	88.74	2)	78.74 ³⁾	102.36 ⁴⁾
2000	-	44.37	48.90	93.27	88.74	2)	78.74 ³⁾	102.36 ⁴⁾

- 1) The dimensions are reference values. They may vary depending on the pressure rating, design and order option.
- 2) Internal diameter depends on the liner, see the measuring tube specification → 90
- 3) Order code for "Design", option F "Fixed flange, short installed length" and option J "Fixed flange, short installed length, 0 x DN inlet/outlet runs"
- 4) Order code for "Design", option G "Fixed flange, long installed length" and option K "Fixed flange, long installed length 0 x DN inlet/outlet runs"

DN 84 to 120 in (2200 to 3000 mm)

DN		Order code for "Design"					K	L
		Option F, J						
[mm]	[in]	D ¹⁾ [in]	E ¹⁾ [in]	F ¹⁾ [in]	M ¹⁾ [in]	[in]	[in]	
-	84	48.31	52.83	101.14	96.61	2)	86.61	
2200	-	48.31	52.83	101.14	96.61	2)	86.61	
-	90	52.44	56.97	109.41	104.88	2)	94.49	
2400	-	52.44	56.97	109.57	104.88	2)	94.49	
-	96	56.34	60.87	117.20	112.64	2)	96.46	
-	102	59.69	64.21	123.90	119.37	2)	102.36	
2600	-	56.77	61.30	118.07	113.50	2)	102.36	
-	108	63.07	67.64	130.71	126.14	2)	108.27	
2800	-	60.91	65.43	126.34	121.77	2)	110.24	
-	114	66.46	70.98	137.44	132.87	2)	114.17	
3000	-	64.84	69.37	134.21	129.65	2)	118.11	
-	120	69.84	74.37	144.21	139.65	2)	120.08	

- 1) The dimensions are reference values. They may vary depending on the pressure rating, design and order option.
- 2) Internal diameter depends on the liner, see the measuring tube specification → 90

Flange connections

Fixed flange

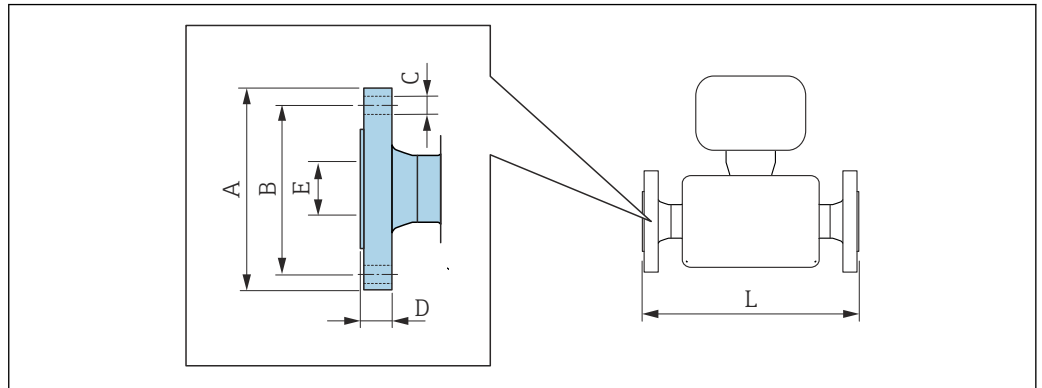

A0015621

Flange according to ASME B16.5, Class 150
Carbon steel: order code for "Process connection", option A1K
Stainless steel: order code for "Process connection", option A1S

DN		A	B	C	D	E	L
[mm]	[in]	[in]	[in]	[in]	[in]	[in]	[in]
25	1	4.25	3.12	4 × Ø0.63	0.5	1)	2)
40	1 ½	5	3.88	4 × Ø0.63	0.63		
50	2	6	4.75	4 × Ø0.75	0.69		
80	3	7.5	6	4 × Ø0.75	0.88		
100	4	9	7.5	8 × Ø0.75	0.88		
150	6	11	9.5	8 × Ø0.88	0.94		
200	8	13.5	11.75	8 × Ø0.88	1.06		
250	10	16	14.25	12 × Ø1	1.17		
300	12	19	17	12 × Ø1	1.19		
350	14	21.06	18.75	12 × Ø1.13	1.39		
400	16	23.43	21.25	16 × Ø1.13	1.46		
450	18	25	22.75	16 × Ø1.25	1.58		
500	20	27.56	25	20 × Ø1.25	1.7		
600	24	32.09	29.5	20 × Ø1.37	1.89		

Surface roughness (flange): Ra 250 to 492 µm

- 1) Depends on the liner → ☞ 90
- 2) Total length is independent of the process connections. Length according to DVGW (German Technical and Scientific Association for Gas and Water) → ☞ 74 (compact version) → ☞ 77 (remote version)

Flange according to ASME B16.5, Class 300
Carbon steel: order code for "Process connection", option A2K
Stainless steel: order code for "Process connection", option A2S

DN		A	B	C	D	E	L
[in]	[mm]	[in]	[in]	[in]	[in]	[in]	[in]
1	25	4.88	3.5	4 × Ø0.75	0.63	1)	2)
1 ½	40	6.12	4.5	4 × Ø0.88	0.75		
2	50	6.5	5	8 × Ø0.75	0.82		

Flange according to ASME B16.5, Class 300							
Carbon steel: order code for "Process connection", option A2K							
Stainless steel: order code for "Process connection", option A2S							
DN		A	B	C	D	E	L
[in]	[mm]	[in]	[in]	[in]	[in]	[in]	[in]
3	80	8.25	6.62	8 × Ø0.88	1.06		
4	100	10	7.88	8 × Ø0.88	1.19		
6	150	12.5	10.62	12 × Ø0.88	1.38		
Surface roughness (flange): Ra 250 to 492 µm							

- 1) Depends on the liner → ☞ 90
- 2) Total length is independent of the process connections. Length according to DVGW (German Technical and Scientific Association for Gas and Water) → ☞ 74 (compact version) → ☞ 77 (remote version)

Flange according to AWWA, Cl. D							
Order code for "Process connection", option W1K							
DN		A	B	C	D	E	L
[in]	[mm]	[in]	[in]	[in]	[in]	[in]	[in]
28	700	36.50	34.00	28 × Ø1.38	1.31	1)	2)
30	-	38.74	36.00	28 × Ø1.38	1.38		
32	800	41.73	38.50	28 × Ø1.65	1.50		
36	900	45.98	42.75	32 × Ø1.65	1.63		
40	1000	50.75	47.25	36 × Ø1.65	1.63		
42	-	52.99	49.50	36 × Ø1.65	1.75		
48	1200	59.49	56.00	44 × Ø1.65	1.88		
54	-	66.26	62.75	44 × Ø1.89	2.13		
60	-	73.03	69.25	52 × Ø1.89	2.25		
66	-	80.00	76.00	52 × Ø1.89	2.50		
72	1800	86.50	82.50	60 × Ø1.89	2.63		
78	-	92.99	89.00	64 × Ø2.13	2.75		
84	-	99.80	95.50	64 × Ø2.13	2.88		
90	-	106.50	107.00	68 × Ø2.36	3.00		
96	-	113.27	108.50	68 × Ø2.37	3.25		
102	-	120.00	114.50	68 × Ø2.63	3.25		
108	-	126.73	120.75	68 × Ø2.63	3.38		
114	-	133.50	126.75	68 × Ø2.87	3.50		
120	-	140.24	132.75	68 × Ø2.87	3.50		
Surface roughness (flange): Ra 250 to 492 µm							

- 1) Depends on the liner → ☞ 90
- 2) Total length is independent of the process connections. Installed length according to DVGW → ☞ 74 (compact version) → ☞ 77 (remote version)

Lap joint flange

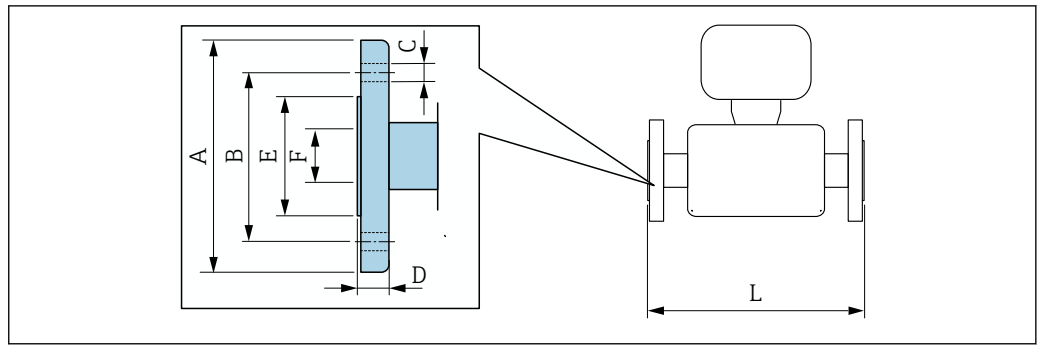

A0037862

Lap joint flange according to ASME B16.5, Class 150
Carbon steel: order code for "Process connection", option A12
Stainless steel: order code for "Process connection", option A14

DN		A	B	C	D	E	F	L
[mm]	[in]	[in]	[in]	[in]	[in]	[in]	[in]	[in]
25	1	4.33	3.15	4 × Ø0.63	0.55	1.93	1)	2)
40	1 ½	4.92	3.86	4 × Ø0.63	0.69	2.8		
50	2	5.91	4.76	4 × Ø0.75	0.75	3.46		
80	3	7.48	5.98	4 × Ø0.75	0.94	4.72		
100	4	9.06	7.48	8 × Ø0.75	0.94	5.83		
150	6	11.02	9.49	8 × Ø0.91	0.98	8.23		
200	8	13.58	11.73	8 × Ø0.91	1.14	10.39		
250	10	15.94	14.25	12 × Ø0.98	1.18	12.48		
300	12	19.09	17.01	12 × Ø0.98	1.26	14.88		

Surface roughness (flange): Ra 248 to 492 µin

- 1) Depends on the liner → 90
- 2) Total length is independent of the process connections. Length according to DVGW (German Technical and Scientific Association for Gas and Water) → 74 (compact version) → 77 (remote version)

Accessories

Ground disks for flange connections

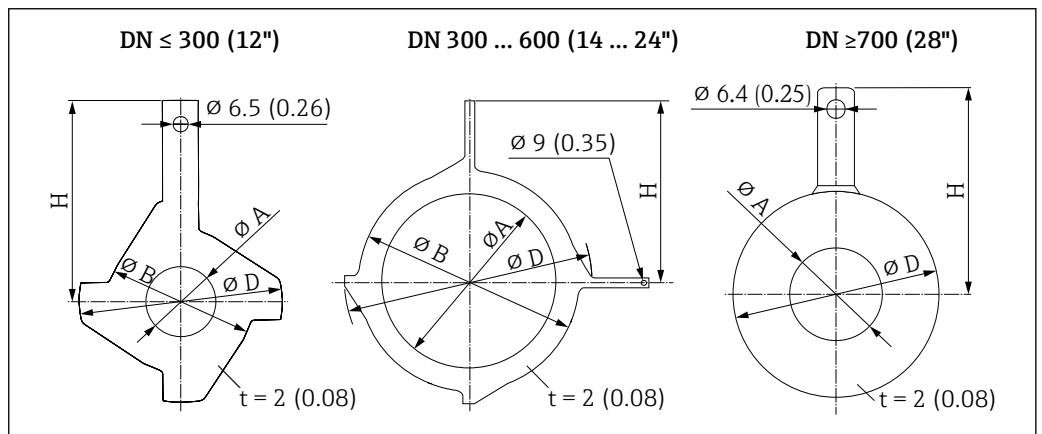

A0015442

DN		Pressure rating	A		B		D		H	
[mm]	[inch]		[mm]	[inch]	[mm]	[inch]	[mm]	[inch]	[mm]	[inch]
25	1"	1)	26	1.02	62	2.44	77.5	3.05	87.5	3.44
32	1 ¼"	1)	35	1.38	80	3.15	87.5	3.44	94.5	3.72
40	1 ½"	1)	41	1.61	82	3.23	101	3.98	103	4.06
50	2"	1)	52	2.05	101	3.98	115.5	4.55	108	4.25
65	2 ½"	1)	68	2.68	121	4.76	131.5	5.18	118	4.65
80	3"	1)	80	3.15	131	5.16	154.5	6.08	135	5.31
100	4"	1)	104	4.09	156	6.14	186.5	7.34	153	6.02
125	5"	1)	130	5.12	187	7.36	206.5	8.13	160	6.30
150	6"	1)	158	6.22	217	8.54	256	10.08	184	7.24
200	8"	1)	206	8.11	267	10.51	288	11.34	205	8.07
250	10"	1)	260	10.2	328	12.91	359	14.13	240	9.45
300	12"	PN 10 PN 16 Cl. 150	312	12.3	375	14.76	413	16.26	273	10.75
		PN 25 JIS 10K JIS 20K	310	12.2	375	14.76	404	15.91	268	10.55
350	14"	PN 6	420	16.5	420	16.54	479	18.86	365	14.37
		PN 10								
		PN 16								
375	15"	PN 16	461	18.2	461	18.2	523	20.6	395	15.6
400	16"	PN 6	470	18.5	470	18.50	542	21.34	395	15.55
		PN 10								
		PN 16								
450	18"	PN 6	525	20.7	525	20.67	583	22.95	417	16.42
		PN 10								
		PN 16								
500	20"	PN 6	575	22.6	575	22.64	650	25.59	460	18.11
		PN 10								
		PN 16								
600	24"	PN 6	676	26.6	676	26.61	766	30.16	522	20.55
		PN 10								
		PN 16								
700	28"	PN 6	697	27.4	-	-	786	30.94	460	18.11
		PN10	693	27.3	-	-	813	32.01	480	18.9
		PN16	687	27.1	-	-	807	31.77	490	19.29
		Cl, D	693	27.3	-	-	832	32.76	494	19.45
750	30"	Cl, D	743	29.3	-	-	833	32.8	523	20.59
800	32"	PN 6	799	31.5	-	-	893	35.16	520	20.47
		PN 10	795	31.3	-	-	920	36.22	540	21.26
		PN 16	789	31.1	-	-	914	35.98	550	21.65
		Cl, D	795	31.3	-	-	940	37.01	561	22.09
900	36"	PN 6	897	35.3	-	-	993	39.09	570	22.44

DN		Pressure rating	A		B		D		H	
[mm]	[inch]		[mm]	[inch]	[mm]	[inch]	[mm]	[inch]	[mm]	[inch]
		PN 10	893	35.2	-	-	1020	40.16	590	23.23
		PN 16	886	34.9	-	-	1014	39.92	595	23.43
		Cl, D	893	35.2	-	-	1048	41.26	615	24.21
1000	40"	PN 6	999	39.3	-	-	1093	43.03	620	24.41
		PN 10	995	39.2	-	-	1127	44.37	650	25.59
		PN 16	988	38.9	-	-	1131	44.53	660	25.98
		Cl, D	995	39.2	-	-	1163	45.79	675	26.57
-	42"	PN 6	1044	41.1	-	-	1220	48.03	704	27.72
1200	48"	PN 6	1203	47.4	-	-	1310	51.57	733	28.86
		PN 10	1196	47.1	-	-	1344	52.91	760	29.92
		PN 16	1196	47.1	-	-	1385	54.53	786	30.94
		Cl, D	1188	46.8	-	-	1345	52.95	775	30.51

- 1) In the case of DN 25 to 250, ground disks can be used for all the flange standards/pressure ratings which can be supplied in the standard version

Weight

All values (weight exclusive of packaging material) refer to devices with flanges of the standard pressure rating.
The weight may be lower than indicated depending on the pressure rating and design.

Weight in SI units

Order code for "Design", option C, D, E, H, I : DN 25 to 400 mm (1 to 16 in)			
Nominal diameter		Reference values EN (DIN), AS, JIS	
[mm]	[in]	Pressure rating	[kg]
25	1	PN 40	10
32	-	PN 40	11
40	1 ½	PN 40	12
50	2	PN 40	13
65	-	PN 16	13
80	3	PN 16	15
100	4	PN 16	18
125	-	PN 16	25
150	6	PN 16	31
200	8	PN 10	52
250	10	PN 10	81
300	12	PN 10	95
350	14	PN 6	106
375	15	PN 6	121
400	16	PN 6	121

Order code for "Design", option F, J: DN 450 to 2 000 mm (18 to 78 in)			
Nominal diameter		Reference values	
[mm]	[in]	EN (DIN) (PN16) [kg]	AS (PN 16) [kg]
450	18	142	138
500	20	182	186
600	24	227	266
700	28	291	369
-	30	-	447
800	32	353	524
900	36	444	704
1000	40	566	785
-	42	-	-
1200	48	843	1229
-	54	-	-
1400	-	1204	-
-	60	-	-
1600	-	1845	-
-	66	-	-

Order code for "Design", option F, J: DN 450 to 2 000 mm (18 to 78 in)			
Nominal diameter		Reference values	
		EN (DIN) (PN16)	AS (PN 16)
[mm]	[in]	[kg]	[kg]
1800	72	2 357	-
-	78	2 929	-
2000	-	2 929	-

Order code for "Design", option F, J: DN 2 200 to 3 000 mm (84 to 120 in)		
Nominal diameter		Reference values
		EN (DIN) (PN6)
[mm]	[in]	[kg]
-	84	-
2200	-	3 422
-	90	-
2400	-	4 094
-	96	-
-	102	-
2600	-	7 601.5
-	108	-
2800	-	9 466.5
-	114	-
3000	-	11 911
-	120	-

Order code for "Design", option G, K: DN 450 to 2 000 mm (18 to 78 in)		
Nominal diameter		Reference values
		EN (DIN) (PN 6)
[mm]	[in]	[kg]
450	18	161
500	20	156
600	24	208
700	28	304
-	30	-
800	32	357
900	36	485
1000	40	589
-	42	-
1200	48	850
-	54	850
1400	-	1 300
-	60	-
1600	-	1 845

Order code for "Design", option G, K: DN 450 to 2 000 mm (18 to 78 in)		
Nominal diameter		Reference values
[mm]	[in]	EN (DIN) (PN 6)
		[kg]
-	66	-
1800	72	2 357
-	78	2 929
2000	-	2 929

Weight in US units

Order code for "Design", option C, D, E, H, I: DN 1 to 16 in (25 to 400 mm)		
Nominal diameter		Reference values
[mm]	[in]	ASME (Class 150)
		[lb]
25	1	11
32	-	-
40	1 ½	15
50	2	20
65	-	-
80	3	31
100	4	42
125	-	-
150	6	73
200	8	115
250	10	198
300	12	284
350	14	379
375	15	-
400	16	448

Order code for "Design", option F, J: DN 18 to 120 in (450 to 3 000 mm)		
Nominal diameter		Reference values
[mm]	[in]	ASME (Class 150), AWWA (Class D)
		[lb]
450	18	421
500	20	503
600	24	666
700	28	587
-	30	701
800	32	845
900	36	1 036
1000	40	1 294
-	42	1 477
1200	48	1 987

Order code for "Design", option F, J: DN 18 to 120 in (450 to 3 000 mm)		
Nominal diameter		Reference values ASME (Class 150), AWWA (Class D)
[mm]	[in]	[lb]
-	54	2 807
1400	-	-
-	60	3 515
1600	-	-
-	66	4 699
1800	72	5 662
-	78	6 864
2000	-	6 864
-	84	8 280
2200	-	-
-	90	10 577
2400	-	-
-	96	15 574.6
-	102	18 023.9
2600	-	-
-	108	20 783.0
2800	-	-
-	114	24 060.2
3000	-	-
-	120	27 724.3

Order code for "Design", option G, K: DN 18 to 78 in (450 to 2 000 mm)		
Nominal diameter		Reference values ASME (Class 150), AWWA (Class D)
[mm]	[in]	[lb]
450	18	562
500	20	628
600	24	893
700	28	882
-	30	1 014
800	32	1 213
900	36	1 764
1000	40	1 984
-	42	2 426
1200	48	3 087
-	54	4 851
1400	-	-
-	60	5 954
1600	-	-
-	66	8 158

Order code for "Design", option G, K: DN 18 to 78 in (450 to 2000 mm)		
Nominal diameter		Reference values ASME (Class 150), AWWA (Class D)
[mm]	[in]	[lb]
1800	72	9040
-	78	10 143
2000	-	-

Measuring tube specification



The values are reference values and can vary depending on the pressure rating, design and order option.

Nominal diameter		Pressure rating				Measuring tube internal diameter					
		EN (DIN)	ASME AWWA	AS 2129 AS 4087	JIS	Hard rubber		Polyurethane		PTFE	
[mm]	[in]					[mm]	[in]	[mm]	[in]	[mm]	[in]
25	1	PN 40	Class 150	-	20K	-	-	24	0.93	25	1.00
32	-	PN 40	-	-	20K	-	-	32	1.28	34	1.34
40	1 ½	PN 40	Class 150	-	20K	-	-	38	1.51	40	1.57
50	2	PN 40	Class 150	Table E, PN 16	10K	50	1.98	50	1.98	52	2.04
50 ¹⁾	2	PN 40	Class 150	Table E, PN 16	10K	32	1.26	-	-	-	-
65	-	PN 16	-	-	10K	66	2.60	66	2.60	68	2.67
65 ¹⁾	-	PN 16	-	-	10K	38	1.50	-	-	-	-
80	3	PN 16	Class 150	Table E, PN 16	10K	79	3.11	79	3.11	80	3.15
80 ¹⁾	3	PN 16	Class 150	Table E, PN 16	10K	50	1.97	-	-	-	-
100	4	PN 16	Class 150	Table E, PN 16	10K	101	3.99	104	4.11	104	4.09
100 ¹⁾	4	PN 16	Class 150	Table E, PN 16	10K	66	2.60	-	-	-	-
125	-	PN 16	-	-	10K	127	4.99	130	5.11	129	5.08
125 ¹⁾	-	PN 16	-	-	10K	79	3.11	-	-	-	-
150	6	PN 16	Class 150	Table E, PN 16	10K	155	6.11	158	6.23	156	6.15
150 ¹⁾	6	PN 16	Class 150	Table E, PN 16	10K	102	4.02	-	-	-	-
200	8	PN 10	Class 150	Table E, PN 16	10K	204	8.02	207	8.14	202	7.96
200 ¹⁾	8	PN 16	Class 150	Table E, PN 16	10K	127	5.00	-	-	-	-
250	10	PN 10	Class 150	Table E, PN 16	10K	258	10.14	261	10.26	256	10.09
250 ¹⁾	10	PN 16	Class 150	Table E, PN 16	10K	156	6.14	-	-	-	-
300	12	PN 10	Class 150	Table E, PN 16	10K	309	12.15	312	12.26	306	12.03
300 ¹⁾	12	PN 16	Class 150	Table E, PN 16	10K	204	8.03	-	-	-	-
350	14	PN 10	Class 150	Table E, PN 16	10K	337	13.3	340	13.4	-	-
375	15	-	-	PN 16	10K	389	15.3	392	15.4	-	-
400	16	PN 10	Class 150	Table E, PN 16	10K	387	15.2	390	15.4	-	-
450	18	PN 10	Class 150	-	10K	436	17.2	439	17.3	-	-
500	20	PN 10	Class 150	Table E, PN 16	10K	487	19.2	490	19.3	-	-
600	24	PN 10	Class 150	Table E, PN 16	10K	585	23.0	588	23.1	-	-
700	28	PN 10	Class D	Table E, PN 16	10K	694	27.3	697	27.4	-	-
750	30	-	Class D	Table E, PN 16	10K	743	29.3	746	29.4	-	-
800	32	PN 10	Class D	Table E, PN 16	-	794	31.3	797	31.4	-	-

Nominal diameter		Pressure rating				Measuring tube internal diameter					
		EN (DIN)	ASME AWWA	AS 2129 AS 4087	JIS	Hard rubber		Polyurethane		PTFE	
[mm]	[in]					[mm]	[in]	[mm]	[in]	[mm]	[in]
900	36	PN 10	Class D	Table E, PN 16	-	895	35.2	898	35.4	-	-
1000	40	PN 6	Class D	Table E, PN 16	-	991	39.0	994	39.1	-	-
-	42	-	Class D	-	-	1043	41.1	1043	41.1	-	-
1200	48	PN 6	Class D	Table E, PN 16	-	1191	46.9	1197	47.1	-	-
-	54	-	Class D	-	-	1339	52.7	-	-	-	-
1400	-	PN 6	-	-	-	1402	55.2	-	-	-	-
-	60	-	Class D	-	-	1492	58.7	-	-	-	-
1600	-	PN 6	-	-	-	1600	63.0	-	-	-	-
-	66	-	Class D	-	-	1638	64.5	-	-	-	-
1800	72	PN 6	-	-	-	1786	70.3	-	-	-	-
-	78	-	Class D	-	-	1989	78.3	-	-	-	-
2000	-	PN 6	-	-	-	1989	78.3	-	-	-	-
-	84	-	Class D	-	-	2099	84.0	-	-	-	-
2200	-	PN 6	-	-	-	2194	87.8	-	-	-	-
-	90	-	Class D	-	-	2246	89.8	-	-	-	-
2400	-	PN 6	-	-	-	2391	94.1	-	-	-	-
-	96	-	Class D	-	-	2382	93.8	-	-	-	-
-	102	-	Class D	-	-	2533	99.7	-	-	-	-
2600	-	PN 6	-	-	-	2580	101.6	-	-	-	-
-	108	-	Class D	-	-	2683	105.6	-	-	-	-
2800	-	PN 6	-	-	-	2780	109.5	-	-	-	-
-	114	-	Class D	-	-	2832	111.5	-	-	-	-
3000	-	PN 6	-	-	-	2976	117.2	-	-	-	-
-	120	-	Class D	-	-	2980	117.3	-	-	-	-

1) Order code for "Design", option C

Materials

Transmitter housing

Compact version

- Order code for "Housing", option **A** "Compact, alu, coated": Aluminum, AlSi10Mg, coated
- Order code for "Housing", option **M**: polycarbonate plastic
- Window material:
 - For order code for "Housing", option **A**: glass
 - For order code for "Housing", option **M**: plastic

Remote version (wall-mount housing)

- Order code for "Housing", option **P** "Remote, alu, coated": Aluminum, AlSi10Mg, coated
- Order code for "Housing", option **N**: polycarbonate plastic
- Window material:
 - For order code for "Housing", option **P**: glass
 - For order code for "Housing", option **N**: plastic

Sensor connection housing

- Aluminum, AlSi10Mg, coated
- Polycarbonate plastic (only in conjunction with order code for "Sensor option", options CA, C3, CB, CC, CD, CD)

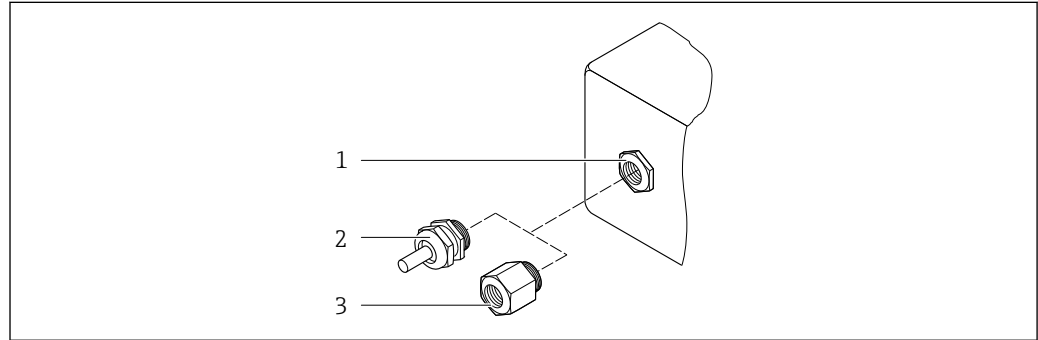
Cable entries/cable glands

☑ 30 Possible cable entries/cable glands

- 1 Female thread M20 × 1.5
- 2 Cable gland M20 × 1.5
- 3 Adapter for cable entry with female thread G ½" or NPT ½"

Compact and remote versions and sensor connection housing

Cable entry/cable gland	Material
Cable gland M20 × 1.5	<ul style="list-style-type: none"> ■ Plastic ■ Nickel-plated brass
Remote version: cable gland M20 × 1.5 Option of armored connecting cable	<ul style="list-style-type: none"> ■ Sensor connection housing: Nickel-plated brass ■ Transmitter wall-mount housing: Plastic
Adapter for cable entry with female thread G ½" or NPT ½"	Nickel-plated brass

Device plug

Electrical connection	Material
Plug M12x1	<ul style="list-style-type: none"> ■ Socket: Stainless steel, 1.4404 (316L) ■ Contact housing: Polyamide ■ Contacts: Gold-plated brass

Remote version connecting cable

i UV rays can impair the cable outer sheath. Protect the cable from exposure to sun as much as possible.

Electrode and coil current cable:

- Standard cable: PVC cable with copper shield
- Armored cable: PVC cable with copper shield and additional steel wire braided jacket

Sensor housing

- DN 25 to 300 (1 to 12")
 - Aluminum half-shell housing, aluminum, AlSi10Mg, coated
 - Fully welded carbon steel housing with protective varnish
- DN 350 to 3000 (14 to 120")
 - Fully welded carbon steel housing with protective varnish

Measuring tubes

- DN 25 to 600 (1 to 24")
Stainless steel: 1.4301, 1.4306, 304, 304L
- DN 700 to 3000 (28 to 120")
Stainless steel: 1.4301, 304



Liner

- DN 25 to 300 (1 to 12"): PTFE
- DN 25 to 1200 (1 to 48"): polyurethane
- DN 50 to 3000 (2 to 120"): hard rubber

Electrodes

- Stainless steel, 1.4435 (316L)
- Alloy C22, 2.4602 (UNS N06022)
- Tantalum

Process connections

-  For flanges made of carbon steel:
 - DN ≤ 300 (12"): with Al/Zn protective coating or protective varnish
 - DN ≥ 350 (14"): protective varnish
-  All carbon steel lap joint flanges are supplied with a hot-dip galvanized finish.

EN 1092-1 (DIN 2501)

Fixed flange

- Carbon steel:
 - DN ≤ 300: S235JRG2, S235JR+N, P245GH, A105, E250C
 - DN 350 to 3000: P245GH, S235JRG2, A105, E250C
- Stainless steel:
 - DN ≤ 300: 1.4404, 1.4571, F316L
 - DN 350 to 600: 1.4571, F316L, 1.4404
 - DN 700 to 1000: 1.4404, F316L

Lap joint flange

- Carbon steel DN ≤ 300: S235JRG2, A105, E250C
- Stainless steel DN ≤ 300: 1.4306, 1.4404, 1.4571, F316L

Lap joint flange, stamped plate

- Carbon steel DN ≤ 300: S235JRG2 similar to S235JR+AR or 1.0038
- Stainless steel DN ≤ 300: 1.4301 similar to 304

ASME B16.5

Fixed flange, lap joint flange

- Carbon steel: A105
- Stainless steel: F316L

JIS B2220

- Carbon steel: A105, A350 LF2
- Stainless steel: F316L

AWWA C207

Carbon steel: A105, P265GH, A181 Class 70, E250C, S275JR

AS 2129

Carbon steel: A105, E250C, P235GH, P265GH, S235JRG2

AS 4087

Carbon steel: A105, P265GH, S275JR

Seals

As per DIN EN 1514-1, form IBC

Accessories*Display guard*

Stainless steel, 1.4301 (304L)

Ground disks

- Stainless steel, 1.4435 (316L)
- Alloy C22, 2.4602 (UNS N06022)
- Tantalum

Fitted electrodes

Measurement, reference and empty pipe detection electrodes available as standard with:

- 1.4435 (316L)
- Alloy C22, 2.4602 (UNS N06022)
- Tantalum

Process connections

- EN 1092-1 (DIN 2501)
- ASME B16.5
- JIS B2220
- AS 2129 Table E
- AS 4087 PN 16
- AWWA C207 Class D



For information on the different materials used in the process connections → 93

Surface roughness

Electrodes with 1.4435 (316L); Alloy C22, 2.4602 (UNS N06022); tantalum: < 0.5 µm (19.7 µin)
(All data relate to parts in contact with medium)

Human interface

Operating concept**Operator-oriented menu structure for user-specific tasks**

- Commissioning
- Operation
- Diagnostics
- Expert level

Fast and safe commissioning

- Guided menus ("Make-it-run" wizards) for applications
- Menu guidance with brief descriptions of the individual parameter functions
- Access to the device via Web server
- WLAN access to the device via mobile handheld terminal, tablet or smart phone

Reliable operation

- Operation in local language
- Uniform operating philosophy applied to device and operating tools
- If replacing electronic modules, transfer the device configuration via the integrated memory (HistoROM backup) which contains the process and measuring device data and the event logbook. No need to reconfigure.

Efficient diagnostic behavior increases measurement availability

- Troubleshooting measures can be called up via the device and in the operating tools
- Diverse simulation options, logbook for events that occur and optional line recorder functions

Languages

Can be operated in the following languages:

- Via local operation:
 - English, German, French, Spanish, Italian, Dutch, Portuguese, Polish, Russian, Turkish, Chinese, Japanese, Bahasa (Indonesian), Vietnamese, Czech, Swedish
- Via "FieldCare", "DeviceCare" operating tool:
 - English, German, French, Spanish, Italian, Chinese, Japanese
- Via Web browser (only available for device versions with HART, PROFIBUS DP and EtherNet/IP):
 - English, German, French, Spanish, Italian, Dutch, Portuguese, Polish, Russian, Turkish, Chinese, Japanese, Bahasa (Indonesian), Vietnamese, Czech, Swedish

Local operation

Via display module

Equipment:

- Standard features 4-line, illuminated, graphic display; touch control
- Order code for "Display; operation", option BA "WLAN" offers standard equipment features in addition to access via Web browser

 Information about WLAN interface →  98

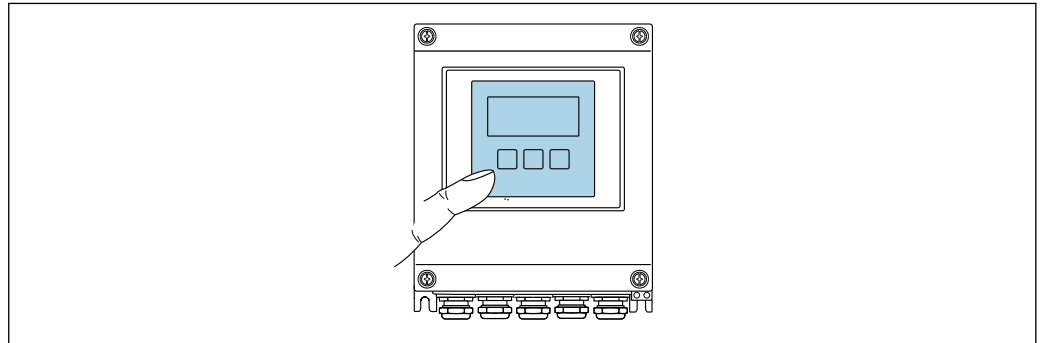

A0032074

 31 Operation with touch control

Display elements

- 4-line, illuminated, graphic display
- White background lighting; switches to red in event of device errors
- Format for displaying measured variables and status variables can be individually configured
- Permitted ambient temperature for the display: -20 to +60 °C (-4 to +140 °F)
The readability of the display may be impaired at temperatures outside the temperature range.

Operating elements

- External operation via touch control (3 optical keys) without opening the housing: , , 
- Operating elements also accessible in the various zones of the hazardous area

Remote operation

Via HART protocol

This communication interface is available in device versions with a HART output.

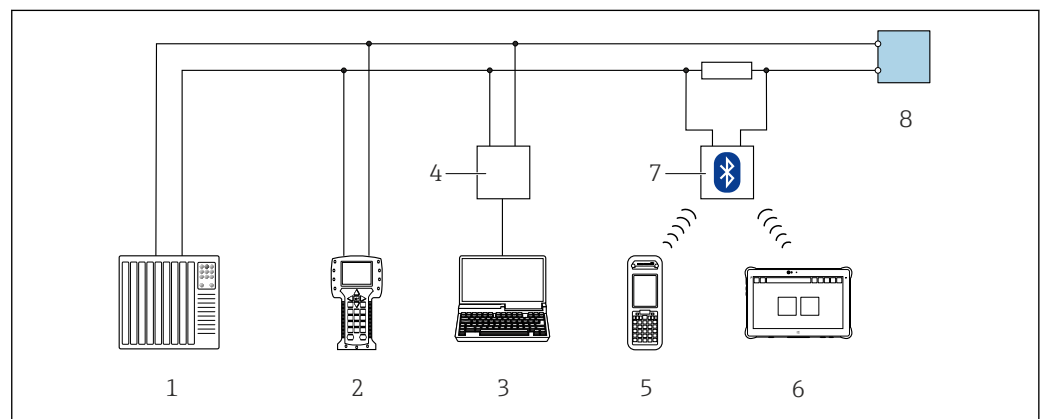

A0028747

 32 Options for remote operation via HART protocol

- 1 Control system (e.g. PLC)
- 2 Field Communicator 475
- 3 Computer with operating tool (e.g. FieldCare, AMS Device Manager, SIMATIC PDM)
- 4 Commubox FXA195 (USB)
- 5 Field Xpert SFX350 or SFX370
- 6 Field Xpert SMT70
- 7 VIATOR Bluetooth modem with connecting cable
- 8 Transmitter

Via PROFIBUS DP network

This communication interface is available in device versions with PROFIBUS DP.

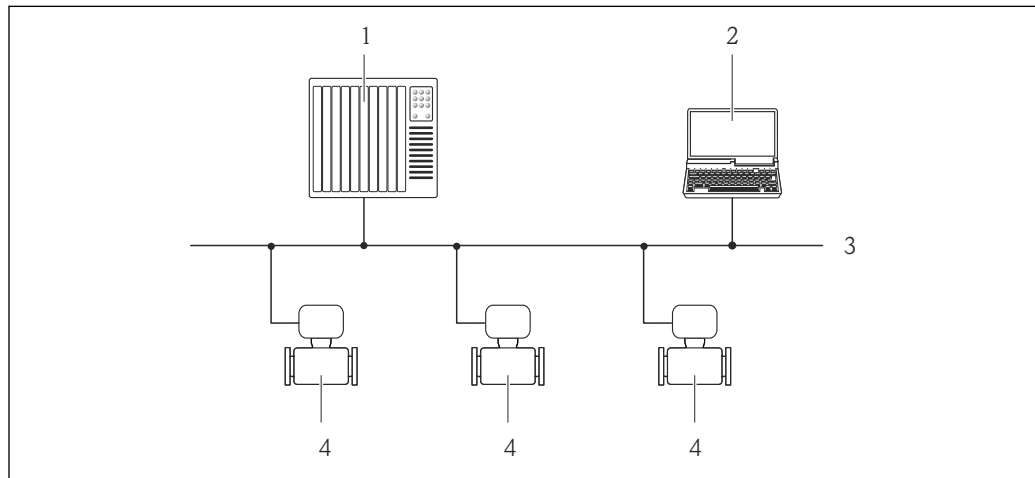

A0020903

33 Options for remote operation via PROFIBUS DP network

- 1 Automation system
- 2 Computer with PROFIBUS network card
- 3 PROFIBUS DP network
- 4 Measuring device

Via Modbus RS485 protocol

This communication interface is available in device versions with a Modbus-RS485 output.

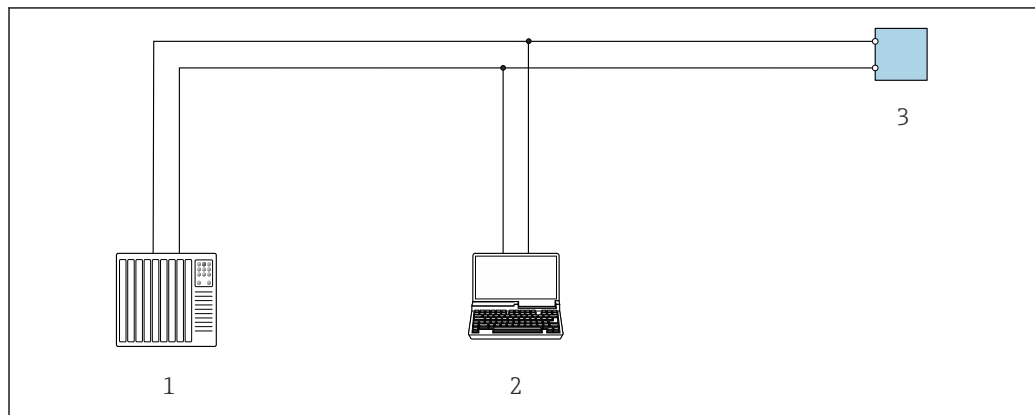

A0029437

34 Options for remote operation via Modbus-RS485 protocol (active)

- 1 Control system (e.g. PLC)
- 2 Computer with Web browser (e.g. Internet Explorer) for accessing the integrated device Web server or with operating tool (e.g. FieldCare, DeviceCare) with COM DTM "CDI Communication TCP/IP" or Modbus DTM
- 3 Transmitter

Via EtherNet/IP network

This communication interface is available in device versions with EtherNet/IP.

Star topology

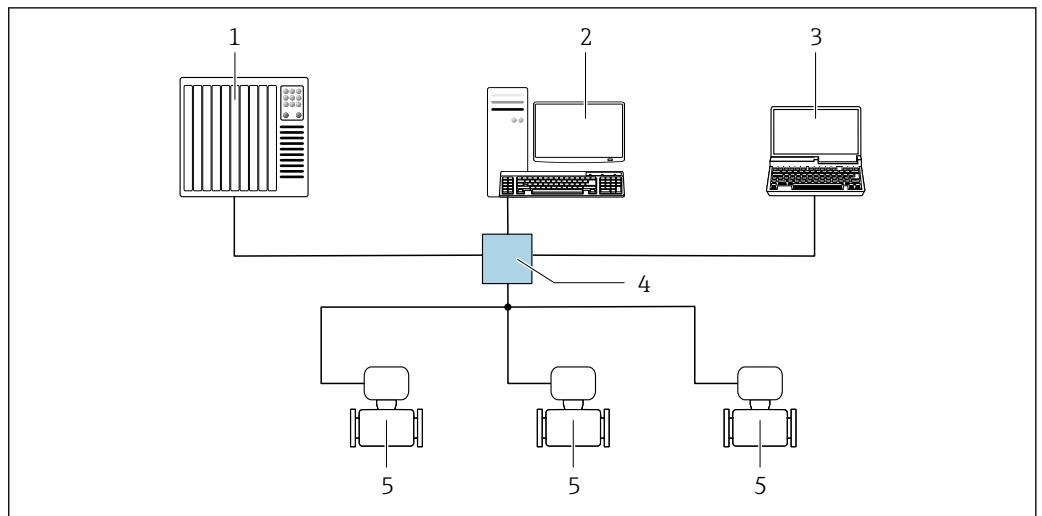

A0032078

35 Options for remote operation via EtherNet/IP network: star topology

- 1 Automation system, e.g. "RSLogix" (Rockwell Automation)
- 2 Workstation for measuring device operation: with Custom Add-On Profile for "RSLogix 5000" (Rockwell Automation) or with Electronic Data Sheet (EDS)
- 3 Computer with Web browser (e.g. Internet Explorer) for accessing the integrated device Web server or computer with operating tool (e.g. FieldCare, DeviceCare) with COM DTM "CDI Communication TCP/IP"
- 4 Ethernet switch
- 5 Measuring device

Service interface

Via service interface (CDI-RJ45)

This communication interface is present in the following device version:

- Order code for "Output", option H: 4 to 20 mA HART, pulse/frequency output, switch output
- Order code for "Output", option I: 4 to 20 mA HART, 2 x pulse/frequency/switch output, status input
- Order code for "Output", option J: 4 to 20 mA HART, certified pulse output, switch output; status input
- Order code for "Output", option L: PROFIBUS DP
- Order code for "Output", option M: Modbus RS485
- Order code for "Output", option O: Modbus RS485, 4 to 20 mA, 2 x pulse/frequency/switch output
- Order code for "Output", option P: Modbus RS485, 4 to 20 mA, certified pulse output, pulse/frequency/switch output
- Order code for "Output", option N: EtherNet/IP

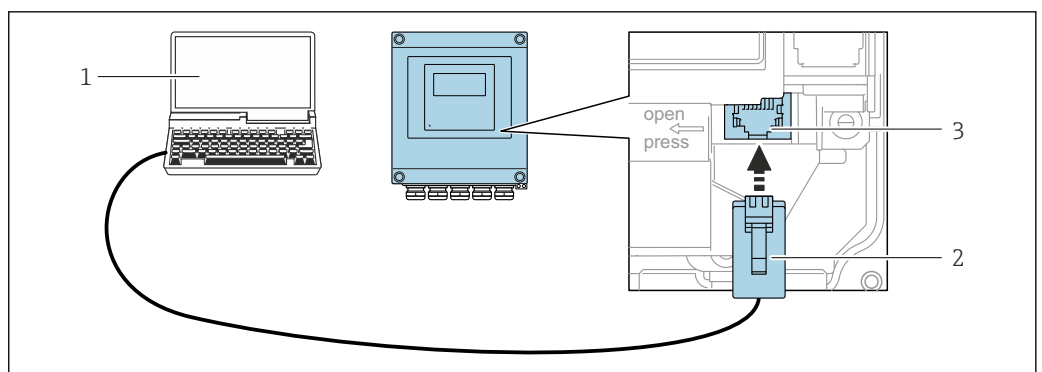

A0029163

36 Connection via service interface (CDI-RJ45)

- 1 Computer with Web browser (e.g. Microsoft Internet Explorer, Microsoft Edge) for accessing the integrated device Web server or with "FieldCare", "DeviceCare" operating tool with COM DTM "CDI Communication TCP/IP" or Modbus DTM
- 2 Standard Ethernet connecting cable with RJ45 plug
- 3 Service interface (CDI-RJ45) of the measuring device with access to the integrated Web server

Via WLAN interface

The optional WLAN interface is available on the following device version:

Order code for "Display", option BA "WLAN":

4-line, illuminated, graphic display; touch control + WLAN

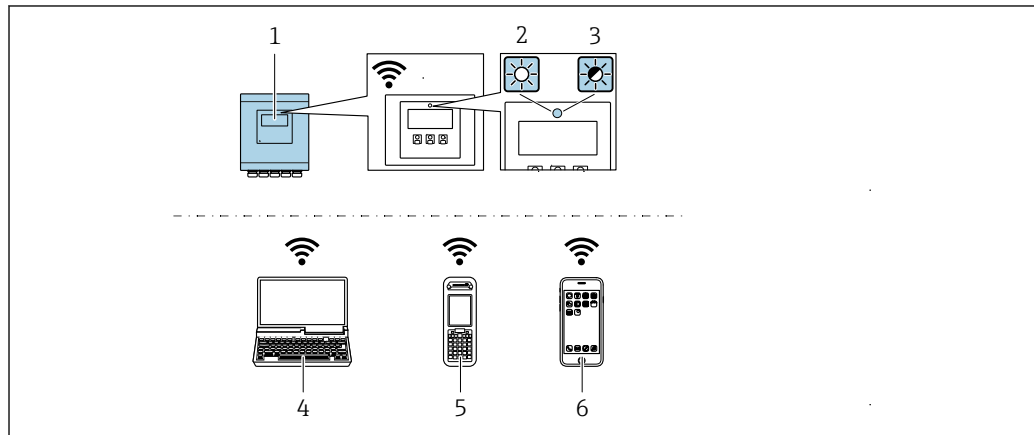

A0043149

- 1 Transmitter with integrated WLAN antenna
- 2 LED lit constantly: WLAN reception is enabled on measuring device
- 3 LED flashing: WLAN connection established between operating unit and measuring device
- 4 Computer with WLAN interface and Web browser (e.g. Microsoft Internet Explorer, Microsoft Edge) for accessing the integrated device Web server or with operating tool (e.g. FieldCare, DeviceCare)
- 5 Mobile handheld terminal with WLAN interface and Web browser (e.g. Microsoft Internet Explorer, Microsoft Edge) for accessing the integrated device Web server or operating tool (e.g. FieldCare, DeviceCare)
- 6 Smart phone or tablet (e.g. Field Xpert SMT70)

Function	WLAN: IEEE 802.11 b/g (2.4 GHz) <ul style="list-style-type: none"> ■ Access point with DHCP server (default setting) ■ Network
Encryption	WPA2-PSK AES-128 (in accordance with IEEE 802.11i)
Configurable WLAN channels	1 to 11
Degree of protection	IP67
Available antenna	Internal antenna
Range	Typically 10 m (32 ft)

Supported operating tools

Different operating tools can be used for local or remote access to the measuring device. Depending on the operating tool used, access is possible with different operating units and via a variety of interfaces.

Supported operating tools	Operating unit	Interface	Additional information
Web browser	Notebook, PC or tablet with Web browser	<ul style="list-style-type: none"> ■ CDI-RJ45 service interface ■ WLAN interface ■ Ethernet-based fieldbus (EtherNet/IP) 	Special Documentation for the device
DeviceCare SFE100	Notebook, PC or tablet with Microsoft Windows system	<ul style="list-style-type: none"> ■ CDI-RJ45 service interface ■ WLAN interface ■ Fieldbus protocol 	→ 105

Supported operating tools	Operating unit	Interface	Additional information
FieldCare SFE500	Notebook, PC or tablet with Microsoft Windows system	<ul style="list-style-type: none"> ■ CDI-RJ45 service interface ■ WLAN interface ■ Fieldbus protocol 	→  105
Device Xpert	Field Xpert SFX 100/350/370	Fieldbus protocol HART	Operating Instructions BA01202S Device description files: Use update function of handheld terminal

 Other operating tools based on FDT technology with a device driver such as DTM/iDTM or DD/EDD can be used for device operation. These operating tools are available from the individual manufacturers. Integration into the following operating tools, among others, is supported:

- FactoryTalk AssetCentre (FTAC) from Rockwell Automation → www.rockwellautomation.com
- Process Device Manager (PDM) from Siemens → www.siemens.com
- Asset Management Solutions (AMS) from Emerson → www.emersonprocess.com
- FieldCommunicator 375/475 from Emerson → www.emersonprocess.com
- Field Device Manager (FDM) from Honeywell → www.honeywellprocess.com
- FieldMate from Yokogawa → www.yokogawa.com
- PACTWare → www.pactware.com

The related device description files are available: www.endress.com → Downloads

Web server



Thanks to the integrated Web server, the device can be operated and configured via a Web browser and via a service interface (CDI-RJ45) or via a WLAN interface. The structure of the operating menu is the same as for the local display. In addition to the measured values, device status information is also displayed, allowing users to monitor the status of the device. Furthermore the device data can be managed and the network parameters can be configured.

A device that has a WLAN interface (can be ordered optionally) is required for the WLAN connection: order code for "Display", option BA "WLAN". The device acts as an Access Point and enables communication by computer or a mobile handheld terminal.

Supported functions

Data exchange between the operating unit (such as a notebook for example) and the measuring device:

- Upload the configuration from the measuring device (XML format, configuration backup)
- Save the configuration to the measuring device (XML format, restore configuration)
- Export event list (.csv file)
- Export parameter settings (.csv file or PDF file, document the measuring point configuration)
- Export the Heartbeat verification log (PDF file, only available with the "Heartbeat Verification" application package)
- Flash firmware version for device firmware upgrade, for instance
- Download driver for system integration
- Visualize up to 1000 saved measured values (only available with the **Extended HistoROM** application package →  103)

 Web server special documentation →  106

HistoROM data management

The measuring device features HistoROM data management. HistoROM data management comprises both the storage and import/export of key device and process data, making operation and servicing far more reliable, secure and efficient.

Additional information on the data storage concept

There are different types of data storage units in which device data are stored and used by the device:

	HistoROM backup	T-DAT	S-DAT
Available data	<ul style="list-style-type: none"> ▪ Event logbook such as diagnostic events for example ▪ Device firmware package ▪ Driver for system integration for exporting via Web server, e.g.: <ul style="list-style-type: none"> ▪ GSD for PROFIBUS DP ▪ EDS for EtherNet/IP 	<ul style="list-style-type: none"> ▪ Measured value logging ("Extended HistoROM" order option) ▪ Current parameter data record (used by firmware at run time) ▪ Peakhold indicator (min/max values) ▪ Totalizer values 	<ul style="list-style-type: none"> ▪ Sensor data: nominal diameter etc. ▪ Serial number ▪ Calibration data ▪ Device configuration (e.g. SW options, fixed I/O or multi I/O)
Storage location	Fixed on the user interface board in the connection compartment	Attachable to the user interface board in the connection compartment	In the sensor plug in the transmitter neck part

Data backup

Automatic

- The most important device data (sensor and transmitter) are automatically saved in the DAT modules
- If the transmitter or measuring device is replaced: once the T-DAT containing the previous device data has been exchanged, the new measuring device is ready for operation again immediately without any errors
- If the sensor is replaced: once the sensor has been replaced, new sensor data are transferred from the S-DAT in the measuring device and the measuring device is ready for operation again immediately without any errors

Data transmission

Manual

- Transfer of a device configuration to another device using the export function of the specific operating tool, e.g. with FieldCare, DeviceCare or Web server: to duplicate the configuration or to store in an archive (e.g. for backup purposes)
- Transmission of the drivers for system integration via Web server, e.g.:
 - GSD for PROFIBUS DP
 - EDS for EtherNet/IP

Event list

Automatic

- Chronological display of up to 20 event messages in the events list
- If the **Extended HistoROM** application package (order option) is enabled: up to 100 event messages are displayed in the events list along with a time stamp, plain text description and remedial measures
- The events list can be exported and displayed via a variety of interfaces and operating tools e.g. DeviceCare, FieldCare or Web server

Data logging

Manual

If the **Extended HistoROM** application package (order option) is enabled:



- Record up to 1000 measured values via 1 to 4 channels
- User configurable recording interval
- Record up to 250 measured values via each of the 4 memory channels
- Export the measured value log via a variety of interfaces and operating tools e.g. FieldCare, DeviceCare or web server

Certificates and approvals

Current certificates and approvals for the product are available via the Product Configurator at www.endress.com.

1. Select the product using the filters and search field.
2. Open the product page.

The **Configuration** button opens the Product Configurator.

CE mark	<p>The device meets the legal requirements of the applicable EU Directives. These are listed in the corresponding EU Declaration of Conformity along with the standards applied.</p> <p>Endress+Hauser confirms successful testing of the device by affixing to it the CE mark.</p>
UKCA marking	<p>The device meets the legal requirements of the applicable UK regulations (Statutory Instruments). These are listed in the UKCA Declaration of Conformity along with the designated standards. By selecting the order option for UKCA marking, Endress+Hauser confirms a successful evaluation and testing of the device by affixing the UKCA mark.</p> <p>Contact address Endress+Hauser UK: Endress+Hauser Ltd. Floats Road Manchester M23 9NF United Kingdom www.uk.endress.com</p>
RCM mark	<p>The measuring system meets the EMC requirements of the "Australian Communications and Media Authority (ACMA)".</p>
Ex approval	<p>The devices are certified for use in hazardous areas and the relevant safety instructions are provided in the separate "Control Drawing" document. Reference is made to this document on the nameplate.</p>
Drinking water approval	<ul style="list-style-type: none"> ■ ACS ■ KTW/W270 ■ NSF 61 ■ WRAS BS 6920
HART certification	<p>HART interface</p> <p>The measuring device is certified and registered by the FieldComm Group. The measuring system meets all the requirements of the following specifications:</p> <ul style="list-style-type: none"> ■ Certified according to HART 7 ■ The device can also be operated with certified devices of other manufacturers (interoperability)
PROFIBUS conformity	<p>PROFIBUS interface</p> <p>The measuring device is registered with PI (PROFIBUS and PROFINET International). It meets all the requirements of PROFIBUS PA Profile 3.02 specifications and can also be operated with certified devices of other manufacturers (interoperability).</p>
Modbus RS485 certification	<p>The measuring device meets all the requirements of the MODBUS/TCP conformity test and has the "MODBUS/TCP Conformance Test Policy, Version 2.0". The measuring device has successfully passed all the test procedures carried out.</p>
EtherNet/IP certification	<p>The measuring device is certified and registered by the ODVA (Open Device Vendor Association). The measuring system meets all the requirements of the following specifications:</p> <ul style="list-style-type: none"> ■ Certified in accordance with the ODVA Conformance Test ■ EtherNet/IP Performance Test ■ EtherNet/IP PlugFest compliance ■ The device can also be operated with certified devices of other manufacturers (interoperability)
Radio approval	<p>The measuring device has radio approval.</p> <p> For detailed information regarding radio approval, see the Special Documentation →  106</p>
Measuring instrument approval	<p>The measuring device is (optionally) approved as a cold water meter (MI-001) for volume measurement in service subject to legal metrological control in accordance with the European Measuring Instruments Directive 2014/32/EU (MID).</p> <p>The measuring device is qualified to OIML R49: 2013.</p>

Other standards and guidelines

- EN 60529
Degrees of protection provided by enclosures (IP code)
- EN 61010-1
Safety requirements for electrical equipment for measurement, control and laboratory use - general requirements
- IEC/EN 61326-3-2
Emission in accordance with Class A requirements. Electromagnetic compatibility (EMC requirements).
- ANSI/ISA-61010-1 (82.02.01)
Safety Requirements for Electrical Equipment for Measurement, Control and Laboratory Use - Part 1 General Requirements
- CAN/CSA-C22.2 No. 61010-1-12
Safety Requirements for Electrical Equipment for Measurement, Control and Laboratory Use - Part 1 General Requirements
- NAMUR NE 21
Electromagnetic compatibility (EMC) of industrial process and laboratory control equipment
- NAMUR NE 32
Data retention in the event of a power failure in field and control instruments with microprocessors
- NAMUR NE 43
Standardization of the signal level for the breakdown information of digital transmitters with analog output signal.
- NAMUR NE 53
Software of field devices and signal-processing devices with digital electronics
- NAMUR NE 105
Specifications for integrating fieldbus devices in engineering tools for field devices
- NAMUR NE 107
Self-monitoring and diagnosis of field devices
- NAMUR NE 131
Requirements for field devices for standard applications

Ordering information

Detailed ordering information is available for your nearest sales organization www.addresses.endress.com or in the Product Configurator under www.endress.com :

1. Click Corporate
2. Select the country
3. Click Products
4. Select the product using the filters and search field
5. Open the product page

The Configuration button to the right of the product image opens the Product Configurator.

Product Configurator - the tool for individual product configuration

- Up-to-the-minute configuration data
 - Depending on the device: Direct input of measuring point-specific information such as measuring range or operating language
 - Automatic verification of exclusion criteria
 - Automatic creation of the order code and its breakdown in PDF or Excel output format
 - Ability to order directly in the Endress+Hauser Online Shop

Application packages

Many different application packages are available to enhance the functionality of the device. Such packages might be needed to address safety aspects or specific application requirements.

The application packages can be ordered with the device or subsequently from Endress+Hauser. Detailed information on the order code in question is available from your local Endress+Hauser sales center or on the product page of the Endress+Hauser website: www.endress.com.

Cleaning	Package	Description
	Electrode cleaning circuit (ECC)	The electrode cleaning circuit (ECC) function has been developed to have a solution for applications where magnetite (Fe ₃ O ₄) deposits frequently occur (e.g. hot water). Since magnetite is highly conductive this build up leads to measuring errors and ultimately to the loss of signal. The application package is designed to avoid build-up of very conductive matter and thin layers (typical of magnetite).



Diagnostics functions	Package	Description
	Extended HistoROM	<p>Comprises extended functions concerning the event log and the activation of the measured value memory.</p> <p>Event log: Memory volume is extended from 20 message entries (standard version) to up to 100 entries.</p> <p>Data logging (line recorder):</p> <ul style="list-style-type: none"> ▪ Memory capacity for up to 1000 measured values is activated. ▪ 250 measured values can be output via each of the 4 memory channels. The recording interval can be defined and configured by the user. ▪ Measured value logs can be accessed via the local display or operating tool e.g. FieldCare, DeviceCare or Web server.

Heartbeat Technology	Package	Description
	Heartbeat Verification +Monitoring	<p>Heartbeat Verification Meets the requirement for traceable verification to DIN ISO 9001:2008 Chapter 7.6 a) "Control of monitoring and measuring equipment".</p> <ul style="list-style-type: none"> ▪ Functional testing in the installed state without interrupting the process. ▪ Traceable verification results on request, including a report. ▪ Simple testing process via local operation or other operating interfaces. ▪ Clear measuring point assessment (pass/fail) with high test coverage within the framework of manufacturer specifications. ▪ Extension of calibration intervals according to operator's risk assessment. <p>Heartbeat Monitoring Continuously supplies data, which are characteristic of the measuring principle, to an external condition monitoring system for the purpose of preventive maintenance or process analysis. These data enable the operator to:</p> <ul style="list-style-type: none"> ▪ Draw conclusions - using these data and other information - about the impact process influences (such as corrosion, abrasion, buildup etc.) have on the measuring performance over time. ▪ Schedule servicing in time. ▪ Monitor the process or product quality, e.g. gas pockets.

Accessories

Various accessories, which can be ordered with the device or subsequently from Endress+Hauser, are available for the device. Detailed information on the order code in question is available from your local Endress+Hauser sales center or on the product page of the Endress+Hauser website: www.endress.com.





Device-specific accessories	For the transmitter	
	Accessories	Description
Promag 400 transmitter	<p>Transmitter for replacement or storage. Use the order code to define the following specifications:</p> <ul style="list-style-type: none"> ▪ Approvals ▪ Output/input ▪ Display/operation ▪ Housing ▪ Software <p> For details, see Installation Instructions EA00104D</p>	







Display guard	Is used to protect the display against impact or scoring, for example from sand in desert areas.  Order number: 71228792  Installation Instructions EA01093D
Connecting cable for remote version	Coil current and electrode cables, various lengths, reinforced cables available on request.
Ground cable	Set, consisting of two ground cables for potential equalization.
Post mounting kit	Post mounting kit for transmitter.
Compact → Remote conversion kit	For converting a compact device version to a remote device version.
Conversion kit Promag 50/53 → Promag 400	For converting a Promag with transmitter 50/53 to a Promag 400.

For the sensor



Accessory	Description
Ground disks	Are used to ground the medium in lined measuring tubes to ensure proper measurement.  For details, see Installation Instructions EA00070D

Communication-specific accessories



Accessories	Description
Commubox FXA195 HART	For intrinsically safe HART communication with FieldCare via the USB interface.  Technical Information TI00404F
Commubox FXA291	Connects Endress+Hauser field devices with a CDI interface (= Endress+Hauser Common Data Interface) and the USB port of a computer or laptop.  Technical Information TI405C/07
HART Loop Converter HMX50	Is used to evaluate and convert dynamic HART process variables to analog current signals or limit values.  <ul style="list-style-type: none"> ▪ Technical Information TI00429F ▪ Operating Instructions BA00371F
Wireless HART adapter SWA70	Is used for the wireless connection of field devices. The WirelessHART adapter can be easily integrated into field devices and existing infrastructures, offers data protection and transmission safety and can be operated in parallel with other wireless networks with minimum cabling complexity.  Operating Instructions BA00061S
Fieldgate FXA42	Is used to transmit the measured values of connected 4 to 20 mA analog measuring devices, as well as digital measuring devices  <ul style="list-style-type: none"> ▪ Technical Information TI01297S ▪ Operating Instructions BA01778S ▪ Product page: www.endress.com/fxa42

Field Xpert SMT70	<p>The Field Xpert SMT70 tablet PC for device configuration enables mobile plant asset management in hazardous and non-hazardous areas. It is suitable for commissioning and maintenance staff to manage field instruments with a digital communication interface and to record progress.</p> <p>This tablet PC is designed as an all-in-one solution with a preinstalled driver library and is an easy-to-use, touch-sensitive tool which can be used to manage field instruments throughout their entire life cycle.</p> <ul style="list-style-type: none">  Technical Information TI01342S  Operating Instructions BA01709S  Product page: www.endress.com/smt70
Field Xpert SMT77	<p>The Field Xpert SMT77 tablet PC for device configuration enables mobile plant asset management in areas categorized as Ex Zone 1.</p> <ul style="list-style-type: none">  Technical Information TI01418S  Operating Instructions BA01923S  Product page: www.endress.com/smt77

Service-specific accessories

Accessory	Description
Applicator	<p>Software for selecting and sizing Endress+Hauser measuring devices:</p> <ul style="list-style-type: none"> ▪ Choice of measuring devices with industrial requirements ▪ Calculation of all the necessary data for identifying the optimum flowmeter: e.g. nominal diameter, pressure loss, flow velocity and accuracy. ▪ Graphic illustration of the calculation results ▪ Determination of the partial order code, administration, documentation and access to all project-related data and parameters over the entire life cycle of a project. <p>Applicator is available:</p> <ul style="list-style-type: none"> ▪ Via the Internet: https://portal.endress.com/webapp/applicator ▪ As a downloadable DVD for local PC installation.
W@M	<p>W@M Life Cycle Management</p> <p>Improved productivity with information at your fingertips. Data relevant to a plant and its components is generated from the first stages of planning and during the asset's complete life cycle.</p> <p>W@M Life Cycle Management is an open and flexible information platform with online and on-site tools. Instant access for your staff to current, in-depth data shortens your plant's engineering time, speeds up procurement processes and increases plant uptime.</p> <p>Combined with the right services, W@M Life Cycle Management boosts productivity in every phase. For more information, see: www.endress.com/lifecyclemanagement</p>
FieldCare	<p>FDT-based plant asset management tool from Endress+Hauser. It can configure all smart field units in your system and helps you manage them. By using the status information, it is also a simple but effective way of checking their status and condition.</p> <ul style="list-style-type: none">  Operating Instructions BA00027S and BA00059S
DeviceCare	<p>Tool for connecting and configuring Endress+Hauser field devices.</p> <ul style="list-style-type: none">  Innovation brochure IN01047S
Commubox FXA291	<p>Connects Endress+Hauser field devices with a CDI interface (= Endress+Hauser Common Data Interface) and the USB port of a computer or laptop.</p> <ul style="list-style-type: none">  Technical Information TI00405C

System components

Accessories	Description
Memograph M graphic data manager	<p>The Memograph M graphic data manager provides information on all the relevant measured variables. Measured values are recorded correctly, limit values are monitored and measuring points analyzed. The data are stored in the 256 MB internal memory and also on a SD card or USB stick.</p> <ul style="list-style-type: none">  Technical Information TI00133R  Operating Instructions BA00247R

Supplementary documentation

 For an overview of the scope of the associated Technical Documentation, refer to the following:

- *W@M Device Viewer* (www.endress.com/deviceviewer): Enter the serial number from the nameplate
- *Endress+Hauser Operations App*: Enter the serial number from the nameplate or scan the matrix code on the nameplate

Standard documentation

Brief Operating Instructions

Brief Operating Instructions for the sensor

Measuring device	Documentation code
Proline Promag W	KA01266D

Transmitter Brief Operating Instructions

Measuring device	Documentation code			
	HART	PROFIBUS DP	Modbus RS485	EtherNet/IP
Proline 400	KA01263D	KA01420D	KA01419D	KA01418D

Operating Instructions

Measuring device	Documentation code			
	HART	PROFIBUS DP	Modbus RS485	EtherNet/IP
Promag W 400	BA01063D	BA01234D	BA01231D	BA01214D

Description of device parameters

Measuring device	Documentation code			
	HART	PROFIBUS DP	Modbus RS485	EtherNet/IP
Promag 400	GP01043D	GP01044D	GP01045D	GP01046D

Supplementary device-dependent documentation

Special Documentation

Content	Documentation code
Display modules A309/A310	SD01793D
Information on Custody Transfer Measurement	SD02038D
Information on Custody Transfer Measurement	SD02561D

Content	Documentation code			
	HART	PROFIBUS DP	Modbus RS485	EtherNet/IP
Web server	SD01811D	SD01813D	SD01812D	SD01814D
Heartbeat Verification + Monitoring	SD01847D	SD02569D	SD02568D	SD02570D

Installation Instructions

Content	Comment
Installation instructions for spare part sets and accessories	Documentation code: specified for each individual accessory →  103.

Registered trademarks

HART®

Registered trademark of the FieldComm Group, Austin, USA

PROFIBUS®

Registered trademark of the PROFIBUS User Organization, Karlsruhe, Germany

Modbus®

Registered trademark of SCHNEIDER AUTOMATION, INC.

EtherNet/IP™

Trademark of ODVA, Inc.



www.addresses.endress.com
