



POWER-BREAK® FIELD INSTALLABLE ACCESSORIES

Circuit Protective Devices Department — Plainville, Connecticut 06062

GEH-4374

UNDervOLTAGE RELEASE DEVICE FOR 600-1600A FRAMES

NOTE: UL Listing is voided when the circuit breaker is modified to add an accessory.

WARNING: When installing accessories, the breaker must be completely de-energized and disconnected from the electrical circuit. This is mandatory because breaker must be "ON" during certain stages of installation and testing.

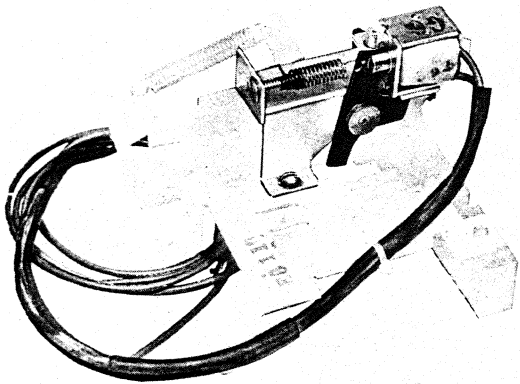

Fig. 1. Undervoltage release accessory shown assembled to mounting plate.

Dropping Resistor
(Provided With 240-600V
—UVR Ratings only)

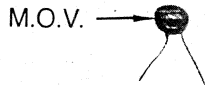
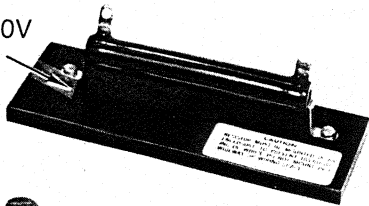

Fig. 2.

ELECTRICAL DATA

Cat. No.	Voltage Rating	Continuous Current (Ma)
TPUV1S	120 Vac	25
TPUV2S①	240 Vac	25
TPUV4S①	480 Vac	25
TPUV6S①	600 Vac	25
TPUV7S	12 Vdc	211
TPUV8S	24 Vdc	104
TPUV9S	48 Vdc	54
TPUV10S	125 Vdc	24
TPUV11S①	250 Vdc	24

① PROVIDED WITH DROPPING RESISTOR

GENERAL DESCRIPTION

The undervoltage release device (UVR) is used to open the circuit breaker when the supply voltage drops to 35-60 percent of its rated value.

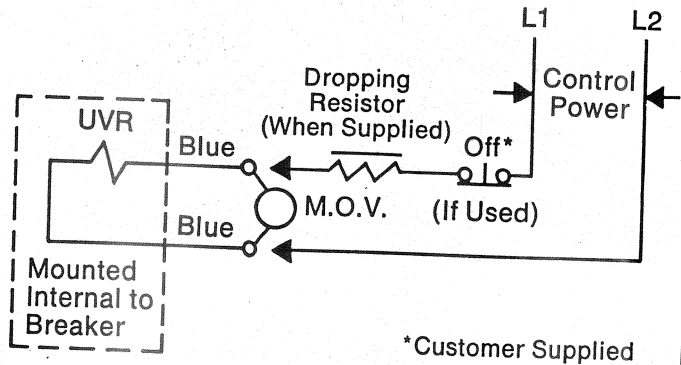

Fig. 3. Wiring Diagram

INSTALLATION

1. Disassemble the circuit breaker cover(s) as outlined in instructions GEH-4393. Do not remove the accessory mounting plate.
2. Remove the slide reset lever spring as shown in Fig. 4. Care should be exercised not to nick or damage the spring in any way, since it will be needed for reassembly.

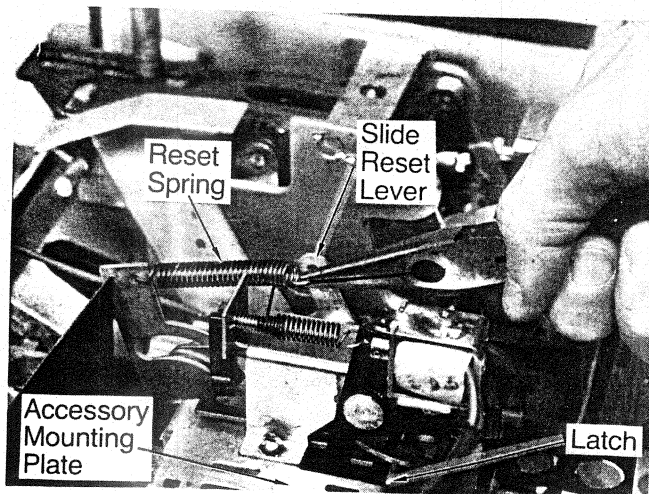

Fig. 4

3. Push the latch and slide reset lever forward to provide mounting clearance for the undervoltage release assembly.

Instructions

These instructions do not purport to cover all details or variations in equipment nor to provide for every possible contingency to be met in connection with installation, operation or maintenance. Should further information be desired or should particular problems arise which are not covered sufficiently for the purchaser's purposes, the matter should be referred to the General Electric Company.

- Position the UVR assembly mounting bracket so that its retaining hole engages the latch pivot post as shown in Fig. 5.

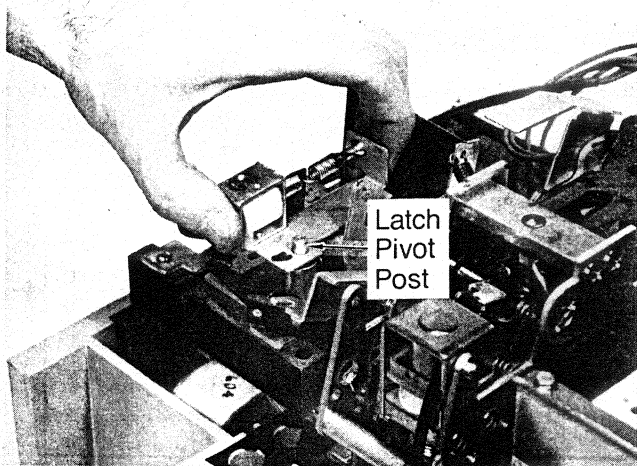

Fig. 5

- Line up the UVR bracket's mounting hole with the tapped hole in the accessory mounting plate. Install screw and lockwasher (Fig. 6). Tighten to 9-11 inch pounds.

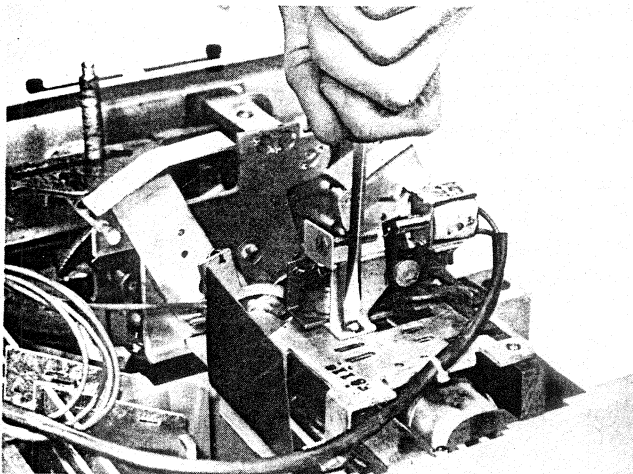

Fig. 6

- Replace slide reset lever spring (Fig. 4).
- Remove knockouts as required in side of base. Each knockout will accommodate up to three bundles of wires (Fig. 7). Remove all sharp edges with a file.
- Clean all debris from inside of breaker.

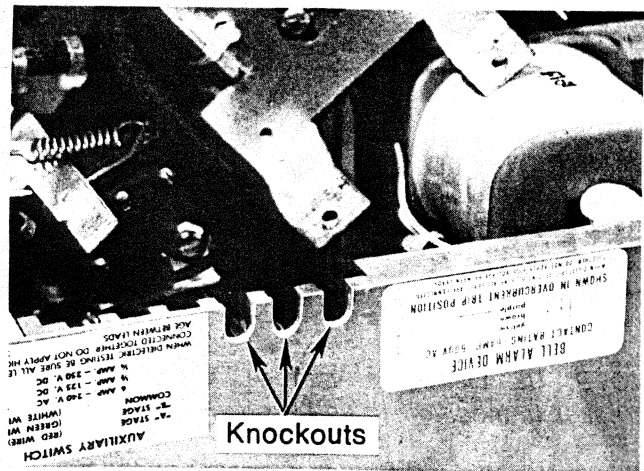

Fig. 7

- Use the wrap provided to secure leads to mounting plate as shown in Fig. 8.

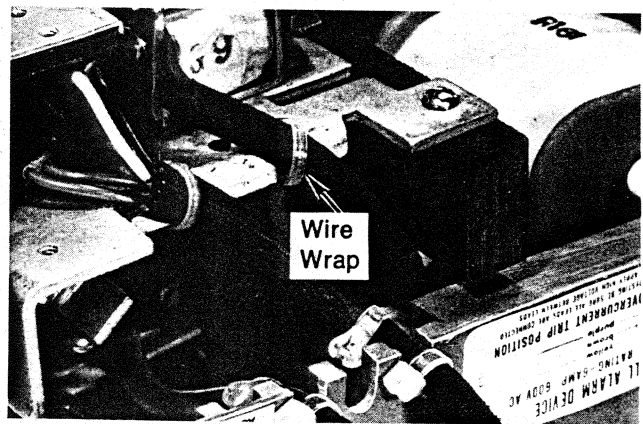

Fig. 8

- Reassemble the breaker as outlined in instructions GEH-4393.
- Mount the dropping register (when supplied) and M.O.V. (Fig. 2). Wire as shown in Fig. 3.
- Functional Check.
 - Apply rated voltage to the UVR coil.
 - Turn the circuit breaker "on."
 - Reduce control voltage. The circuit breaker should trip when the voltage drops to 35-60 percent of its rated value.
- Apply the undervoltage release descriptive label to the left side of the breaker near the lead exit area.